



Chair:

Prof. Bianca M. Colosimo

DOCTORAL PROGRAM IN MECHANICAL ENGINEERING

Within the current global economic scenario, Mechanical Engineering stands out as one of the leading and driving sectors of industrial manufacturing in Italy. In terms of per-capita manufacturing production, our Country ranks 2nd in Europe and 8th on a worldwide scale (Confindustria, Scenari Industriali n.6, November 2015).

In this competitive panorama, and in order to respond to the requests of a challenging sector, the PhD Programme in Mechanical Engineering provides doctoral candidates with a strong scientific training, fostering and refining research and problem-solving abilities with respect to the academic and non-academic *milieu*. Our Programme, organized within the Department of Mechanical Engineering, relies on the development of an interdisciplinary and integrated high-level educational offer, by focusing on a comprehensive scientific proposal, from conception to realization.

All Doctoral Candidates follow a minimum path of three-years, which includes specific courses and lectures, held by Faculty members and foreign professors and experts, in-depth research, laboratories and active cooperation with international industries, institutions and research groups. With this background, our Doctorates are able to blend the exactness of scientific knowledge with the ability to deal with management and industrial issues. In this view, their scientific profiles are suitable for prestigious positions at national and international level within universities and research institutions, large industrial and consulting companies, SMEs.

RESEARCH AREAS

The PhD Programme in Mechanical Engineering covers a number of different disciplines, being devoted, in particular, to innovation and experimental activities in six major research areas; all doctoral thesis displayed in the following pages belong to one of these areas:

Dynamics and vibration of mechanical systems and vehicles: this research line is organized into five research areas, namely Mechatronics and Robotics, Rotordynamics, Wind Engineering, Road Vehicle Dynamics, Railway Dynamics. It features modelling of linear and non-linear dynamic systems, stability and self-excited vibrations, active control of mechanical systems, condition monitoring and diagnostics.

Measurements and experimental Techniques: the Mechanical and Thermal Measurements (MTM) group has its common background in the development and qualification of new measurements techniques, as well as in the customisation and application of well-known measurement principles in innovative fields. MTM major research focus is oriented towards the design, development and metrological characterisation of measurement systems and procedures, the implementation of innovative techniques in sound/vibrations, structural health monitoring, vision, space and rehabilitation measurements.

Machine and vehicle design: this research area is involved in advanced design methods and fitness for purpose of mechanical components. Advanced design methods refer to the definition of multiaxial low and high cycle fatigue life prediction criteria, and the assessment of structural integrity of cracked elements, the prediction of fatigue life criteria of advanced materials as polymer matrix composite materials (short and long fibres), the definition of approaches to predict the influence of shot peening on fatigue strength of mechanical components. Gears, pressure vessels and helicopter components are dealt with. Optimal design and testing of vehicle systems create a synergism between the theoretical and the experimental researches on ground vehicles.

Manufacturing and production systems: this research field gives relevance to the problem of optimal transformation of raw materials into final products, addressing all issues related with the introduction, usage, and evolution of technologies and production systems during the entire product life-cycle. PhD activities, in particular, are developed within the following research fields: Manufacturing Processes (MPR), Manufacturing Systems and Quality (MSQ).

Materials: this area is focused on the study of production process and characterization of materials, for structural and functional applications. Excellent research products were obtained both on fundamental research topics (e.g. nanostructured materials, foamed alloys, chemical phenomena in liquid melts, microstructural design ecc.) and on applied research (e.g. failure and damage analysis, texture analysis, high temperature behaviour, coatings for advanced applications, etc.). The research projects carried out in recent years addressed specifically the following research topics: Steelmaking and Metallurgical Processes, Advanced Materials and Applied Metallurgy.

Methods and tools for product design: two main research topics are addressed in this field: PLM-Product Lifecycle Management, which includes process modelling, engineering knowledge management, product innovation methods, systematic innovation principles and methods, topology optimization systems, and data/process interoperability, and Virtual Prototyping, which includes virtual prototyping for functional and ergonomics product validation, haptic interfaces and interaction, reverse engineering and physics-based modelling and simulation, emotional engineering.

LABORATORIES

One of the key elements of our Doctoral Programme is represented by our laboratories; we feature some of the most unique, active and innovative set-ups in Europe: Cable Dynamics, Characterization of Materials, DBA (Dynamic Bench for Railway Axles), Dynamic Testing, Dynamic Vehicle, Gear and Power Transmission, Geometrical Metrology, High-Temperature Behaviour of Materials, La.S.T., Manufacturing System, Material Testing, Mechatronics, MI_crolab Micro Machining, Microstructural Investigations and Failure Analysis, Outdoor Testing, Physico-Chemical Bulk and Surface Analyses, Power Electronics and Electrical Drives, Process Metallurgy, Reverse Engineering, Robotics, SIP (Structural Integrity and Prognostics), SITEC Laser, Test rig for the Evaluation of Contact Strip Performances, VAL (Vibroacoustics Lab), VB (Vision Bricks Lab), Virtual Prototyping, Water Jet, Wind Tunnel.

INTERNATIONALIZATION

We foster internationalization by strongly recommending and supporting PhD candidates' mobility abroad, for short-term study and longer research periods. We promote, draft and activate European and extra-European Joint Degrees, Double PhD Programmes and Joint Doctoral Thesis; our Department is actively involved in EU-based and governmental third-level education agreements such as Horizon 2020, Erasmus Mundus, Cina Scholarship Council and Brazilian Science Without Borders.

Our international network includes some of the highest-level and best-known universities all over the world, such as MIT-Massachusetts Institute of Technology (US), University of California at Berkeley (US), Imperial College London (UK), Tsinghua University (CN), University of Illinois at Urbana-Champaign (US), Delft University of Technology (NL), University of Michigan (US), École Polytechnique Fédérale de Lausanne (CH), Technische Universität München (DE), University of Southampton (UK), Technical University of Denmark (DK), Pennsylvania State University (US), Chalmers University of Technology (SE), Technion-Israel Institute of Technology (IL), Virginia Tech (US), Technische Universität Darmstadt (DE), University of Bristol (UK), The University of Sheffield (UK), École Centrale Paris (FR), Politécnica de Madrid (ES), Université Laval (CA), Universidad EAFIT (CO), AGH (Akademia Górniczo-Hutnicza) University of Science and Technology (PL).

FACULTY BOARD

Bianca Maria Colosimo (*Head of the PhD Programme*), Stefano Beretta, Andrea Bernasconi, Marco Bocciolone, Marco Boniardi, Monica Bordegoni, Francesco Braghin, Stefano Bruni, Gaetano Cascini, Federico Casolo, Federico Cheli, Alfredo Cigada, Andrea Collina, Giorgio Colombo, Roberto Corradi, Umberto Cugini (*Emeritus*), Giorgio Diana (*Emeritus*), Marco Giglio, Massimiliano Gobbi, Mario Guagliano, Nora Lecis, Stefano Manzoni, Carlo Mapelli, Gianpiero Mastinu, Michele Monno, Paolo Pennacchi, Barbara Previtali, Ferruccio Resta, Daniele Rocchi, Bortolino Saggin, Quirico Semeraro, Tullio Tolio, Maurizio Vedani, Roberto Viganò, Alberto Zasso.

ADVISORY BOARD

Last Name	First Name	Company-Organization	Position
CESARINI	Riccardo	Brembo	Director of Brembo Performance
COELI	Paolo	Centro Ricerche Fiat	Head of Feature Planning at FCA EMEA
GARITO	Domenico	Schaeffler KG	Director Automotive Division Schaeffler KG
BOIOCCHI	Maurizio	Pirelli Tyre	General Manager Technology
FAINELLO	Marco	Ferrari	Head of GT Track Car Development
MURARI	Bruno	ST Microelectronics	Scientific Advisor
POLACH	Oldrich	Bombardier Transportation	Chief Engineer Dynamics
LONGANESI CATTANI	Francesco	PRADA-Luna Rossa	Head of PR
CADET	Daniel	Technical Directorate, Alstom Transport	External Relations Director
FOGLIAZZA	Giuseppe	MCM	Technical Manager
MANDELLI	Massimiliano	Sandvik Italia	Business Development Manager
BIGLIA	Mauro	Officine E. Biglia & C.	Manager
BORSARO	Zeno	Riello Sistemi	Technical Manager
RABINO	Edoardo	Fiat Chrysler Automobiles	Manager
CATTANEO	Stefano	IPG Fibertech	General Manager
CANTELLA	Michele	ATOM	R&D Manager
LIVELLI	Marco	Jobs	CEO
ZIPRANI	Francesco	Marposs	R&D Manager

SCHOLARSHIP SPONSORS

Ferrari Auto, Brembo, Pirelli, Tenaris, Rold Elettronica, Saes Getters, Riva Acciaio, ST Microelectronics, ETS Sistemi Industriali, BLM Group, Luxottica, ESA European Space Agency, Inaf - Osservatorio Astronomico di Brera, Fondazione Università di Mantova, Fondazione Politecnico, MUSP, ITIA-CNR.

FINITE ELEMENT MODELING AND ANALYSIS OF MICROCUTTING PROCESS WITH DEAD METAL CAP

Ali Afsharhanaei - Supervisor: Prof. Massimiliano Annoni

In the last decade production of small parts with acceptable relative accuracy has become a very important topic for industrial sector because of the application of these parts in electronics, aerospace and optics. There are many types of manufacturing process that can produce these miniaturized parts with required accuracy. Micro mechanical cutting is one of the frontiers of production technology and is well known for providing a 3D component with high-aspect-ratio microstructures.

However, despite significant development of machine tools to meet machining accuracy, the basic phenomena behind the fundamental mechanics of the process need to be further investigated. One of the phenomenon which has been stayed ambiguous is called stable Built-Up-Edge (BUE), also called Dead Metal Cap (DMC). In fact, there are numbers of research work for interpretation of cutting process with this piled up material at interface but the detailed description of the mechanics of the process with DMC has not been fully understood. Going to further details, the studies on this phenomenon can be classified into three main categories:

- i) Experimental
- ii) Analytical (mostly slip-line filed

solution method)
 iii) Numerical (Finite Element Method (FEM))
 As expected, each of these techniques has its own drawbacks. For example, experimental studies are limited for analysis of machining with DMC because of the complexity in extracting/measuring the fundamental variables (workpiece deformation behavior, and temperature distribution, etc.) during the machining experiments because of the scale of cutting and technical challenges exist for high speed microcutting. Slip-line field solutions, as a representative of analytical models, are not proper techniques for detailed analysis of cutting process because of the assumptions behind the modeling

development. For example, this modeling technique is based on mathematical formulation of the material plasticity then they cannot provide information on the elastic body of the tool which can play a big role in the micromachining operations. FEM, as the most popular numerical technique, in contrary to both experimental and analytical techniques, can provide information on fundamental thermo-mechanical variables such as temperature, plastic strain, and stress distribution, etc. However, the proper prediction performance of this modeling technique depends on the accuracy of input variables (mostly the contact properties, and material constitutive model). In this thesis, the orthogonal

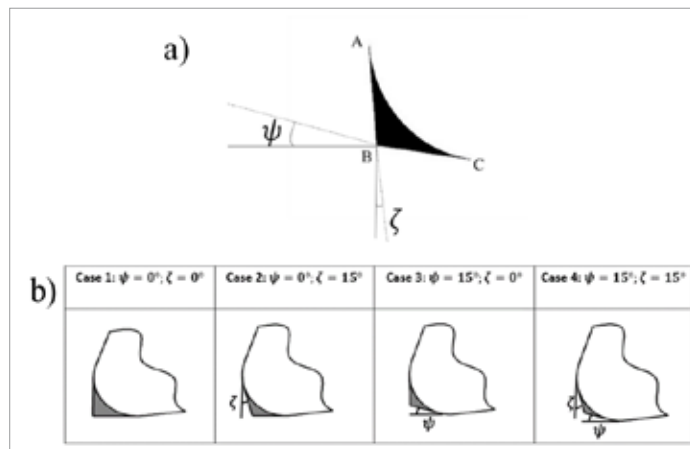

1. a) Sketch of the DMC b) DMC geometries

micromachining FE modeling approaches are used to overcome the drawbacks (not considering DMC stationary properties and proper geometry of DMC) of current FE models. In particular, the proposed approach consist in artificially introducing the piled up material on the surface of the modeled tool edge. With this modeling technique, it is possible to perform comprehensive investigation over geometry of DMC, going into further analysis on the mechanics of micromachining process. Extensive experimental campaigns support the development of the modeling techniques, and the validation of the simulated results.

Based on the experimental observations available in literature, the DMC is modelled with a sharp corner edge and smooth faces (Figure 1a). Geometry of the DMC is constrained in AC face by tool edge radius while it can be characterized by two angles ψ and ζ where they are drawn respectively to parallel and perpendicular directions to the workpiece free surface. The two faces of DMC (along AB and BC) are tangent to the tool edge radius to facilitate the material flow over rake and clearance faces. In this thesis, two magnitudes (0° and 15°) of clearance and rake angles of DMC are considered (Figure 1b) to investigate the sensitivity of the microcutting mechanics with respect to the geometry of DMC.

Arbitrary Lagrangian Eulerian (ALE) mesh distortion control along with adiabatic heating effects are used for 2D modeling of micro orthogonal cutting and

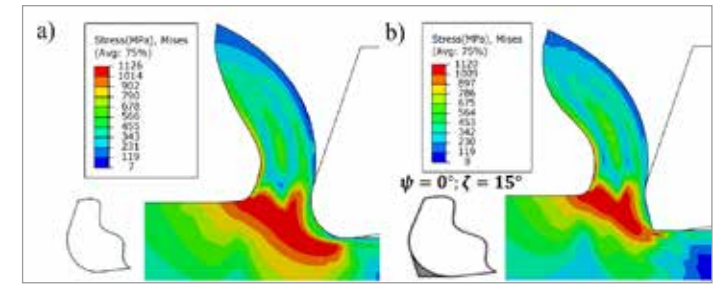

2. Stress distribution for different DMC geometries in the experimental conditions with $v_c = 100$ m/min, $t_u = 9$ μ m: a) rounded tool edge; b) with DMC ($\zeta = 15^\circ$, $\psi = 0^\circ$)

it is found that DMC is affecting and is shown for different cutting

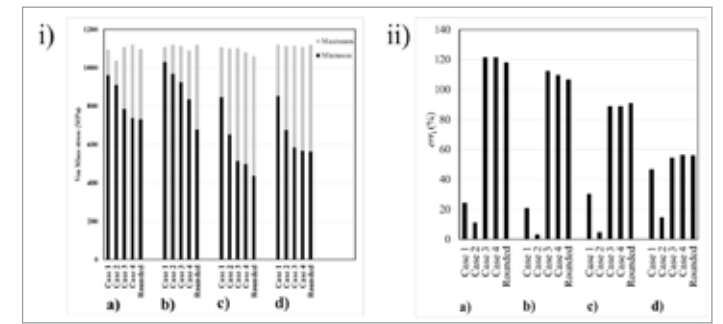

3. i) Von Mises stress distribution along shear plane ii) Percentage error for thrust force prediction (err_t) in the experimental conditions with: a) $v_c = 100$ m/min, $t_u = 6$ μ m; b) $v_c = 300$ m/min, $t_u = 6$ μ m; c) $v_c = 100$ m/min, $t_u = 9$ μ m; d) $v_c = 300$ m/min, $t_u = 9$ μ m

the mechanics of the process significantly. In fact, it is shown that prediction of the process outputs depends on the DMC presence and its geometry. Indeed, DMC occupies the significant portion of tool-chip contact and as a consequence it affects the mechanics of the cutting process in micro scale. Figure 2 indicates the Von Mises stress distribution over chip formation zone and final chip geometry for rounded tool edge (a) and with DMC ($\zeta = 15^\circ$, $\psi = 0^\circ$). The maximum and minimum of this quantity is determined along shear plane in workpiece

conditions and DMC geometry (Figure 3i). The outputs such as chip thickness, cutting and thrust force depend on DMC geometry. For example, the error between predicted thrust force and cutting force can be reduced by DMC consideration (Figure 3ii). Indeed, it is found that one single geometry ($\zeta = 15^\circ$, $\psi = 0^\circ$) of the DMC is producing lowest error for most of cutting conditions.

In order to verify the results captured with 2D ALE approach and 9 μ m tool edge radius, the second completely different simulation modeling (3D Coupled

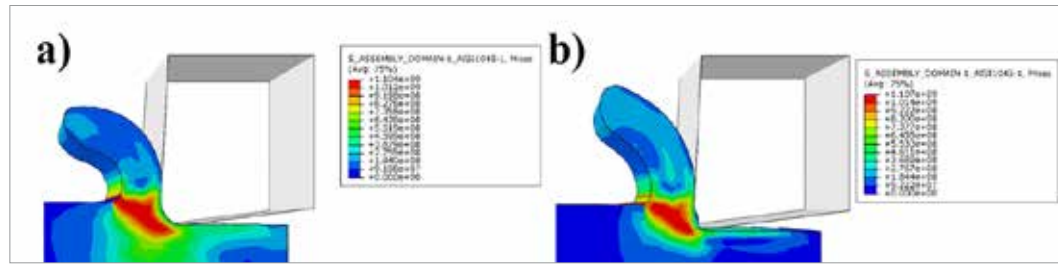

4. Von Mises stress (Pa) distribution for different DMC geometries in the experimental conditions with $v_c = 300$ m/min, $t_u = 60\mu\text{m}$: a) rounded tool edge; b) Case 2 ($\zeta = 15^\circ, \psi = 0^\circ$)

Eulerian Lagrangian (CEL), and edge radius of $60\mu\text{m}$ is designed and compared with experimental results (Figure 4 illustrates the chip formation with this modeling approach). From simulated results, it is found that the same geometry of DMC ($\zeta = 15^\circ, \psi = 0^\circ$) is producing the lowest error for chip thickness, cutting and thrust force (Figure 5) in all of cutting conditions. It is found that if DMC clearance angle is set to 0° ($\psi = 0^\circ$), the thrust force can be reduced significantly this particular DMC angle describes the experimental results better (Figure 5i). In addition, it is argued that the simulation with rounded edge tool tend to predict force ratio almost equal to 1 ($F_c/F_t \approx 1$) while introduction of DMC into process modeling can break this rule and improve the prediction of this quantity (Figure 05ii).

To study in depth the micromachining process and put forward current understanding over mechanics of the process, fully thermo-mechanical properties of the process with CEL approach is considered (Figure 6). Indeed, with this approach it is possible to investigate the DMC deformation with different

material designation and by doing so the proper parameters of Johnson-Cook flow stress model can be suggested. It is found that by reflecting the hardness on the initial yield stress of the material at room temperature coefficient of Johnson-Cook flow stress model (A) the DMC stays stable (Figure 6b) during the microcutting process and the errors (for chip thickness, cutting and thrust forces) between simulation and experimental results stay below 10%.

The temperature on the tool tip is also investigated and it is found that presence of DMC at the interface of chip and tool leads to lower thermal conduction through the tool edge. In facts,

in micromachining simulation with rounded edge tool (Figure 6a), the temperature of the tool tip reached up to 297°C while with DMC (e.g. stable DMC case shown in Figure 6b) the temperature reached 208°C , where this difference indicates a big reduction of temperature at the tool tip in case of DMC consideration in the model. So the tool wear can be protected from higher degrees of temperature. Based on comprehensive investigation with FE models and experimental results, this study found that DMC has significant effects on process mechanics and it is suggested that for proper analysis of micromachining it would be better if the DMC is included in the modeling and

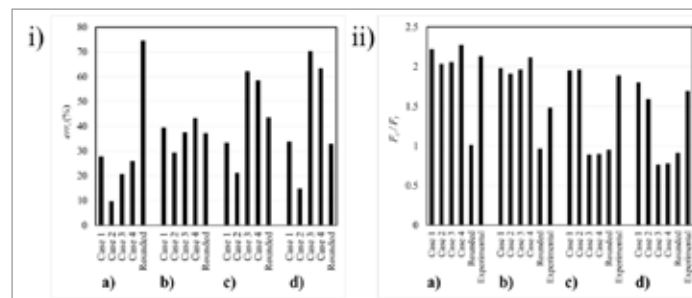

5. i) Percentage error for thrust force prediction (err_t) in the experimental conditions ii) Force ratio prediction in compare with the experimental conditions with: a) $v_c = 100$ m/min, $t_u = 40\mu\text{m}$; b) $v_c = 300$ m/min, $t_u = 40\mu\text{m}$; c) $v_c = 100$ m/min, $t_u = 60\mu\text{m}$; d) $v_c = 300$ m/min, $t_u = 60\mu\text{m}$

interpretation of micromachining process. In fact, it is possible to conclude that DMC plays an important role in micro scale cutting since it occupies the great portion of contact between tool and chip, then it may not be desirable to ignore this phenomenon in interpretation of the process anymore. This is the important achievement of this thesis. In other words, with analysis and results offered in this thesis it is shown that the interpretation of micromachining mechanics cannot be perfectly achieved if DMC is ignored.

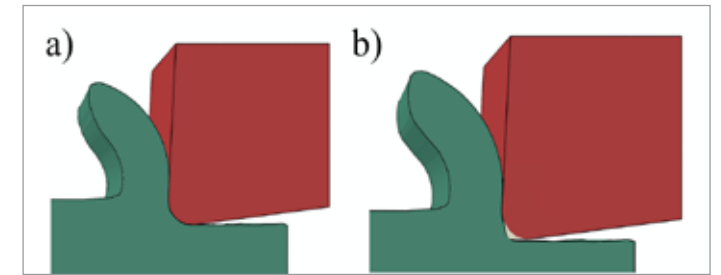

6. Chip formation with a) rounded tool edge; b) stable DMC

A NEW APPROACH TO REPAIR INDUSTRIAL GEARS DAMAGED BY SURFACE DEGRADATION.

Horacio Albertini - Supervisor: Prof. Carlo Gorla

Industrial components in their majority are expensive by two reasons: they are usually large and they are manufactured in batches of small quantities or even individually. In addition, the machinery suppliers or the OEM companies frequently does not have spot components available just in time, thus the delivery of the spare is in long term. Therefore, for the user's point of view, the repair of heavy components might be though the more convenient way to fulfill the issues of maintenance deadlines and premature decommissions. Great effort is spent on the development of new materials, heat treating, manufacturing processes and surfaces finishing to improve the gear performance and production. Although the refurbishment of used gears is actively practiced by the maintenance servicing companies and by the aftersales department of gear manufacturers, there is a lack of researches in the repair field.

Most of the gear teeth are designed using the involute curve and this curve have the property that, even if their profiles are shifted by a correction, a conjugate profile of the teeth of the mating gear can be manufactured to work with, keeping the desired backlash. It means that any gear of any size

applied in heavy machinery can be repaired by modifying their original geometry properties such as the profile shift coefficient and the pressure angle and consequently a redesigned mating gear can be made to keep the same backlash of the original pair. For a long time, the repair of a gear was restricted to the modification of the profile shift coefficient, and the modification of the pressure angle was impracticable due to the kinematics limitations of the conventional gear machinery and the high manufacturing cost of the gear cutters. Nevertheless, nowadays the development of the four points below enable the application of new types of modification for the refurbishment of gears with great accuracy, in a timely manner and saving costs.

1) The coming of CNC machine centers with multi axes and

CNC Gear Grinding machines;
 2) The development of new cutting tool materials which are able to machine parts with surfaces hardness more than 60 HRC;
 3) The advancements in reverse engineering;
 4) The improvement of speed processors of the computers.
 Therefore, this research has intended to provide a new and pragmatic approach to repair industrial gears, creating a criterion of acceptance between gears that are no longer useful and gears that can be reused. The proposed approach consists primarily in excluding severe failures. Among the failure modes, gears that present cracking, fracture, bending fatigue and severe plastic deformation may not be repaired since they have their geometry and mechanical

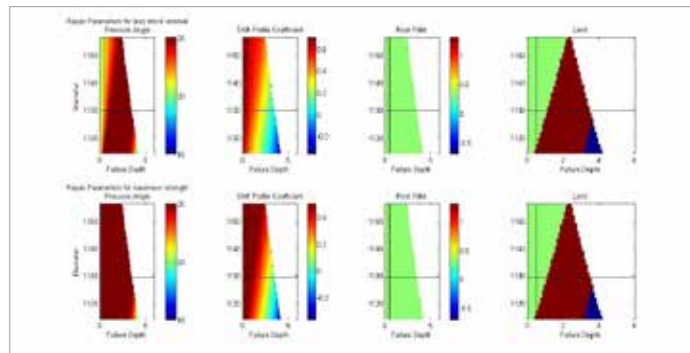

1. Modification chart of the damaged gear in example

properties impaired. Those failures are usually detected by visual inspection using the visual sense or by the aid of a visual inspection method like dye penetrant. Gears that do not present severe failures could thus be repaired and put under power again. Wear, Scuffing and Hertzian Fatigue are failures modes potentially able to be removed by the methodology proposed in this thesis.

The original strength of the gearset shall be known a priori to avoid the designing of a weaker pair. The analytical strength calculation is carried out by inputting the gear geometry, materials and application parameters. KISSsoft™ is used to calculate the geometry and the strength against pitting, bending fatigue, scuffing and micropitting. In case that the gear information is not provided by either the user or the manufacturer, a reverse engineering might be realized to gather the necessary input data to run an accurate calculation. Moreover, during the reverse engineering, the gear testing machine is imperative to determine the position and the depth of the damages found on the gear tooth surface. Once the actual strength of the gear is calculated, the next stage is the modification of the gear geometry to remove the damage, and if it is possible, to increase the strength of the gear. In the code developed in Matlab™, two types of modifications are provided: one that assumes less stock removal during the machining process and other that exploit the best strength a repaired gear could reach. The code deals with the

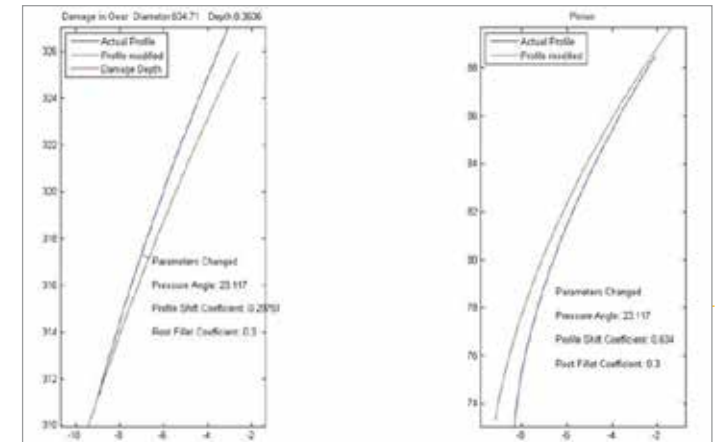

2. Modification chart

modifications of the pressure angle and the profile shift coefficient and thus damages more than one millimeter deep, depending on the gear module size, can be removed. The procedure intends to save both pinion and gear, but in most of the circumstances the pinion, which is the less expensive among the pair elements, must be manufactured to keep the backlash in tolerance. A second analytical strength calculation using the modified parameters is then carried out and the results are compared with the strength of the original geometry. In the hypothesis that occur a strength decreasing, the modification shall not be refused if the safety factors are still above the minimum required by the industrial application. Finally, the drawings of the gearset with their respective modifications are sent to the machine shop and the tooth profile is effectively altered in the workpiece. Through the output of the Matlab™ code, the manufacturing staff is able to decide if the intervention can be

done either by only grinding of or by machining and then grinding of the teeth.

The methodology takes about one day to be executed from the visual inspection to the elaboration of the new drawings regardless of the gearset size. Finally, the repairs of the gearsets carried out in this research are proven less than 40% cheaper than the cost of a new part.

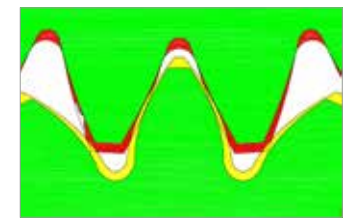

3. Comparative chart of the actual pair and the modified pair. Red area is the stock removal and the yellow area is the amount increased

DESIGN, CALIBRATION AND VALIDATION OF A 10M DYNAMOMETRIC SAILING YACHT FOR FULL SCALE MEASUREMENTS OF AERODYNAMIC LOADS ON SAILS

Ilmas Bayati - Supervisor: Prof. Marco Belloli

This thesis deals with the design, calibration and validation of a 10m dynamometric sailing yacht for full scale measurements of aerodynamic loads on sails (Fig.1). This project aims at building a reference measuring instrument for the validation of numerical codes in the field of aero-hydro-dynamics of sailing yachts. Furthermore, also new systems for sails 3D flying shape detection, as well as for measuring the distributed pressure on sails, are herein developed, calibrated and validated. The results of an extensive wind tunnel preliminary campaign on a scaled model, for assessing the reliability of the whole full scale measuring system, are reported. Furthermore, some promising data acquired during the first full scale navigation campaign are also reported. The thesis can be summarized through the following chapters:

Design of the Sailing Yacht Laboratory Boat

In this chapter the design of the dynamometric boat "Sailing Yacht Laboratory" (SYL) is presented. Starting from a general overview of the new marine research laboratory of Politecnico di Milano (Lecco Innovation Hub) in which the SYL is involved, a detailed description of the structural design is reported along with the building

process. A special attention is paid to the choice of the design specifications, the design methodology, supported by Finite Element Method analysis, the constructive issues and the final requirements, with a special focus on the dynamometric components of the boat. Also an overview of the nautical components of the boat is given within the description of the building process. Furthermore, experimental modal analysis of the framework was carried out to check the frequency content of the real structure.

Calibration of the Dynamometer

The calibration of the dynamometer of the SYL is herein presented. The design of the calibration tests, the methodology and the results are documented in detail. More specifically, the analytical formulation for definition of the external forces in the boat's reference frame due to external loads applied during the calibration tests is explained. Finally, the error sources of the calibration matrix are discussed along with an uncertainty quantification of the related results.

Uncertainty quantification of the dynamometric measuring system

This chapter deals with the

uncertainty quantification of the dynamometric measurement chain, by implementing the consolidated Guidance of Uncertainty in Measurement (GUM). Each module of the measurement chain (load cells, conditioners and Analog to Digital Converter, ADC) are quantified in terms of error sources along with their statistical distributions; then the uncertainties are estimated with reference to a test weight corresponding to the full scale of the load cells and combined according to mutual interaction in the chain (error propagation). Finally the results of the uncertainty quantification is reported and some conclusions are drawn in comparison with the calibration of whole dynamometer.

Global Hardware/Software Architecture

In this chapter the global hardware and software architecture of the SYL is given. Beside the dynamometer, SYL is a new generation test rig, involving also a novel system for the flying shape detection based on Time Of Flight (TOF) technology and a novel pressure system based on MEMS scanner. For the first time this project was aimed at developing a comprehensive full scale experimental system, where measurements forces of the whole

sail plane are taken along with 3D sail shapes and distributed sails pressure, in a synchronous global measuring systems. Details of the sails shape and pressure technology are reported, with a special attention of their metrological quantification and the dedicated wind tunnel setup for assessing the capability of the overall system (hardware/software) on a 1:10 scaled model.

Wind Tunnel Preliminary Tests and Dynamometric Full Scale Results

This final chapter reports the results of a dedicated wind tunnel campaign to assess the overall capabilities of the full scale measuring system (Fig.2). A 1:10 model of a 48' cruiser-racer was adopted for this campaign, the full scale dynamometer was simulated by a 6-component dynamometric balance, the flying shape detection system, based on TOF technology was the same as in full scale, controlled by the full scale master software, which also handled the acquisition of the distributed sails pressure system, as on SYL (Fig.2). The pressure system was the same except for the on the scale model's sails. Promising results of the wind tunnel test are accompanied by and compared to full scale dynamometric results (Fig.3).



Fig.1 Sailing Yacht Laboratory Building Process: Dynamometric Test Rig.



2. Wind tunnel and full scale sessions: disposition of the two laser scanners to detect the flying shape of mainsail and jib or gennaker.

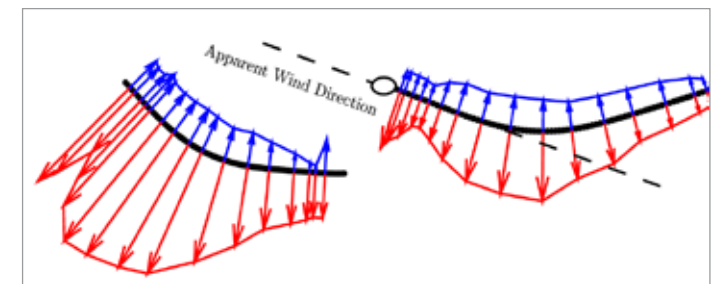

3. Example of measured pressure distributions over measured flying shapes.

INNOVATIVE VIBRATION CONTROL SYSTEMS BASED ON SMART MATERIALS FOR LIGHT STRUCTURES

Marta Berardengo - Supervisor: Prof. Stefano Manzoni

Co-Advisor: Prof. Alfredo Cigada

Structural vibrations have always been a major issue both in the research community and in industry. Mitigation of the vibration level in machine operation leads to an improvement to the comfort of people and in terms of machine functioning and durability. In this field, particular attention is paid to light structures which show some criticalities mainly due to their low weight.

In this scenario, this PhD thesis addresses the vibration control of light structures relying on smart materials, specifically piezoelectric materials and shape memory alloys (SMA). These materials indeed allow to implement control strategies characterised by low weight, thus reducing the load effect on the structure, and able to significantly reduce the power consumption, the control system complexity, and thus the costs.

Despite these materials are not brand new, there is still room for improvement for the methods already available both in terms of performances and robustness. Hence, the main goal of this research activity is to propose new control strategies aimed at improving the damping performances, at increasing the control robustness, and which result easy to apply and characterised by general analytical formulations.

The control approaches considered are passive and semi-active. Particularly, the shunt damping is taken into account to develop controllers based on piezoelectric actuators. As for the employment of SMAs, these materials are used to design a new adaptive tuned mass damper (ATMD) with high adaptation capability.

Piezoelectric shunt damping

The models already available in literature have been compared and refined to have a better description of the behaviour of the electromechanical structure. Relying on these more accurate models, both mono-modal and broadband control have been addressed:

- as for mono-modal control, new tuning strategies for resistive-inductive (LR) impedances were

proposed and compared to the most used in literature and the most robust strategy has been identified. This analysis was carried out by using a general approach valid for both mono- and bi-dimensional structures, which evidenced the asymptotic behaviour of the attenuation performance as function of the system parameters and showed that in mistuned conditions a detailed analysis of the system must be carried out in order to set the value of the electric components. Indeed, often, their optimal values do not provide the best possible attenuation in mistuned conditions. Thus, approximated models were proposed and validated to foresee the control performance

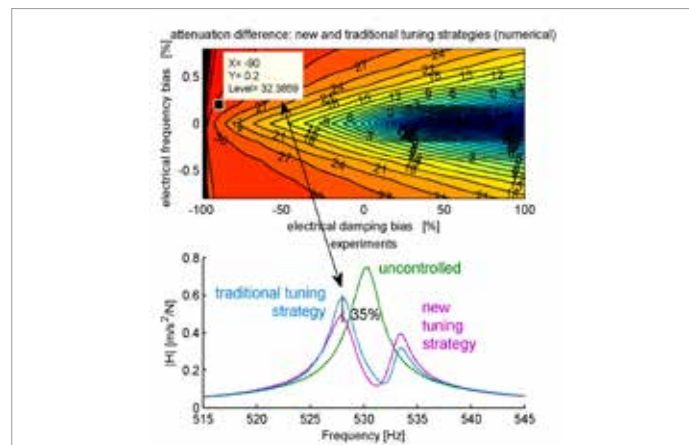

1. New LR tuning strategy: robustness comparison and validation

of mistuned systems. These models allow to have a general overview of the attenuation provided by the shunt in many different configurations by carrying out few numerical simulations, thus allowing to choose the proper value of the impedance parameters as function of the expected working condition. The numerical results have been validated by means of experiments on a bi-dimensional structure;

- as for broadband control, the use of resistive shunt coupled to Negative Capacitances (NCs) was taken into account. General formulations were proposed and validated, showing that a common mathematical description exists for many different shunt impedance layouts. Furthermore, tuning criteria for mono- and multi-mode control were proposed together with a new shunt layout based on a pair of NCs. This new layout showed to significantly improve the attenuation performances if compared to traditional ones. Moreover, a method to make real circuits behave like ideal circuits was proposed and validated. Finally, a technique based on resonant shunts able to improve the damping performance in a given frequency range was presented. All these results were experimentally validated on 2 beam structures;
- since the resistive shunt coupled to NCs was shown to be effective also for mono-modal damping, this technique was compared in terms of performance and robustness to the traditional RL

shunts. The analysis showed that when NCs are added into the shunt circuit, the performance provided by the two control strategies in terms of damping action becomes not too different. Conversely, if no NCs are added, the LR impedance behaves much better than the resistive shunt. Then, a robustness analysis was carried out and it showed that the resistive shunt is more robust than the LR shunt and that it is less sensitive to biases and mistunings.

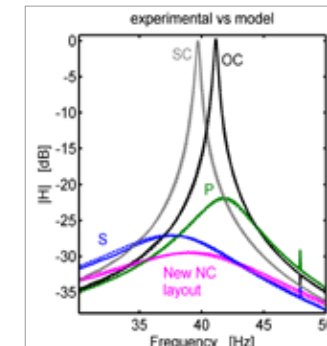

2. New NC layout effectiveness

Furthermore, the resistive shunt impedance is much simpler to build and has shown to provide good broadband attenuation capabilities. Therefore, when mono-modal damping must be carried out, the use of resistive shunt coupled to NCs is a competitive solution. Indeed thanks to its good performances also in terms of broadband control and a high level of robustness, this shunt technique can be considered as the most effective and reliable.

SMA

A fully adaptive tuned mass damper,

based on SMAs and an eddy current damper, has been modelled, built and tested, together with 2 different control strategies. The ATMD eigenfrequency can be changed by exploiting the advantageous features of SMA wires, and its damping can be adjusted by means of the eddy current damper. The layout proposed for the ATMD is different from those already available in literature: usually SMA-based cantilever beams are used as ATMDs, while here a system made up by SMA wires and a mass has been studied. This new layout allows to increase a lot the frequency working range of the ATMD. Indeed, the frequency range in which the eigenfrequency of the ATMD can be changed is about the 100% of the starting eigenfrequency value, while it is about 20% for the ATMDs based on SMA beams available in literature. Besides, the new layout allows to have low currents involved in the heating of the SMA wires, and to use any kind of SMA materials. In light of all these aspects, this thesis has brought to significant advances in the use of piezoelectric shunts and SMA-based ATMDs, with special focus on light structures.



3. New SMA-based ATMD layout

ROBUST OPTIMAL DESIGN OF A SOFT BIAXIAL ACTUATOR

Flavia Buonanno

Supervisors: Prof. Massimiliano Gobbi, Ing. Giacomo Bianchi

This thesis applies numerical optimization techniques in a framework for black-box models, high dimensionality problems, and computational expensive modeling. Two applications are developed with these features in common: they represent two steps in the development of the sole mechanism of the FootGlove, a haptic device able to reproduce the internal volume of user-customized shoes. In the first application, a prototype has been developed, based on an hybrid aluminum and rubber mechanism, mechanically actuated. The second application focused on the optimal design, construction and validation of a soft pneumatic biaxial actuator to be integrated in a next generation prototype of the FootGlove.

A methodological framework has been proposed, that integrates both global sensitivity analysis (for dimensionality reduction) and optimization based on the Parameter Space Investigation (PSI) method. Information can be extracted from the initial sampling used for sensitivity, and boundaries of the problem can be modified by the PSI approach, yielding improved results with respect to those that could be directly obtained from an initial, large dimensional sample.

For design optimization, a general purpose software has been developed, in which FE simulations run in batch through the use of automatic macros. An interface has been included that manages parametric CAD models, updating them directly from the command line. This feature allows for complex geometries to be employed, without the need of writing parametric representations of them directly in the FE environment.

Regarding the soft biaxial actuator, pressurized air has been used for actuation, and its geometry has been conceived in order to develop different displacements in its principal in-plane directions. Specifically, numerical optimization has been applied for maximizing such displacements and the difference among values in the two perpendicular directions. The entire development process has been covered, from the concept, passing through the optimal design, prototype construction, and finally experimental testing. Such process evolved in concomitance with technological aspects related to the fused deposition modeling (FDM) process used for manufacturing.

Different FDM elastomeric filaments (of different materials) have been tensile-tested and their

properties compared in order to select the most suitable filament for printing the soft biaxial actuator. In all filaments, it was observed a strong presence of hysteresis and residual deformation. The filament selected was FilaFlex (TPU), yielding the least residual deformation and cost, the largest stiffness with an acceptable percent energy loss.

In order to obtain a material characterization after FDM processing, tensile tests on printed stripes of FilaFlex have been conducted. Geometry and printing orientation of the stripes was selected according to the different characteristics of local regions of the soft biaxial actuator. Given the small thicknesses, full infill has been used. There is no evidence

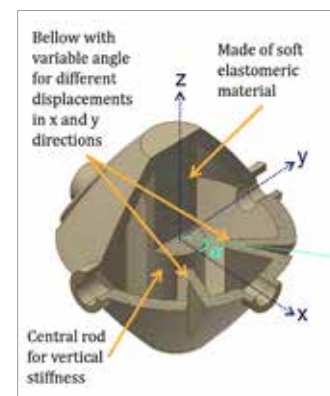

1. Concept of the soft biaxial actuator

of previous literature on the study of mechanical properties of FDM-printed objects with elastomeric TPU, but only for rigid materials. Results from uniaxial testing of printed stripes revealed that deposition path has no significant effect on the mechanical behavior, as opposed to results reported for rigid materials (where in literature it has been demonstrated that deposition path is a factor that affects mechanical performance).

Prototypes of the soft biaxial actuator were constructed and tested. Validation results showed that comparison with initial loading curve shows good agreement between simulated and experimental data, while there is no agreement at all between results for the preconditioned actuator (i.e. after a sequence of loading cycles). This confirmed the validity of the FE model and of material characteristics. On the other hand, the poor agreement in preconditioning evidenced the requirement of improving the material model by including Mullin's effect, such that change in stiffness due softening is accounted for in the right way (while the adopted hyper-elastic models do not take material damage into account).

Robust optimization techniques

have been studied and applied in order to address the effect of uncertainty within the design optimization process. The β -efficient equivalent formulation has been applied to the robust optimization problem of the soft biaxial actuator, where manufacturing considerations were accounted for through the minimization of fabrication time (that can be essentially modeled as a cost). This application showed the effectiveness of the approach using PSI and meta-modeling, for the solution of a design problem with a complex structure and a black-box model.

An extension to the classical approaches to robust optimization has been proposed, where input standard deviations are included in the problem formulation along with a parametric cost function. The approach has been successfully applied to a simple structural problem. It was possible to show the added flexibility that the extended formulation gives to the designer, in that, for a maximum established budget, it is possible to select design solutions with the desired level of accuracy. This desired input accuracies are achieved by tuning the manufacturing process, together with product



2. Experimental setup for measurement of displacement vs. pressure

geometrical parameters. The proposed methodology supplies effective information on the cost-performance relationship, showing the admissible cost range for the given problem and the minimum budget that allows reaching the highest performance over cost ratio

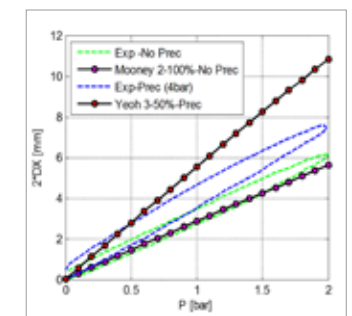

3. Validation of the actuator, with and without preconditioning

OPEN INNOVATION MEETS CHANGEABILITY: STRATEGIC DESIGN ANALYSES FOR CYBER-PHYSICAL INDUSTRY PLATFORMS

Edoardo Colombo - Supervisor: Prof. G. Cascini

Engineering design has to face challenges related to customers' differentiation and high demand for novelty and innovation. On one hand, products must serve a large community of potential customers with diverse needs and mind-sets, as nowadays they have to target multiple markets simultaneously. On the other hand, the availability of choices leads to an increasing importance of niche markets, which in turn increases the availability of choices, leading to a self-enforcing phenomenon. At the same time, sustainability has become a top priority, as resources consumption and waste generation are seriously threatening the quality of life of future generations.

Cyber-physical industry platforms (Figure 1) are a viable concept to address these challenges. Industry platforms can take advantage of an independent community of developers as external sources of innovation; furthermore, their modularity allows customers to tailor the product's features and update them easily, thus increasing the lifecycle value and reducing the need for product substitution. In particular, cyber-physical systems have technological characteristics that make them ideal as industry

platforms. Engineering literature lacks a comprehensive methodology to support the peculiar design of cyber-physical industry platforms. While internal platforms are designed by a finite consortium of entities for a single market, industry platforms are the combination of a central core designed by the platform provider and peripheral modules created by an open community, thus they generate a multi-sided market (Figure 2). Furthermore, product platforms can be customized at the point of sale, while industry platforms change in time according to the customer's preferences and the available modules on the market. Moreover, internal platforms integrators have direct control

over the modules' requirements and specifications; in industry platforms, the developers' community is open.

In order to study these socio-technical interactions, the thesis outlines an initial strategic design methodology blueprint, based on three subsequent design analyses. In the first part, the effect of system architecture on changeability is investigated, so that the system can be easily modified during its lifecycle. Then, a value analysis of the platform configurations is carried out and the most valuable platform configurations and modules are highlighted. Finally, the third part provides a socio-technical simulation of the platform ecosystem, whose results can

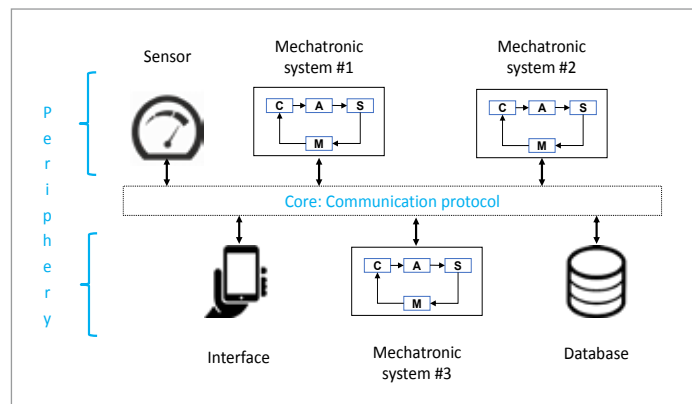

1. model of a cyber-physical industry platform

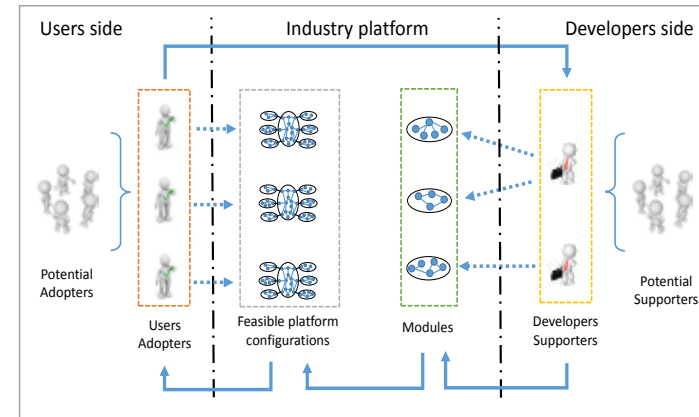

2. socio-technical system constituted by the industry platform and the two communities that form the platform ecosystem

inform designers about both the technical features of the platform and the strategic management of the ecosystem.

Two practical applications are provided. The former scrutinize the effect of modularity and architectural features over a large sample of numerically-generated architectures; the latter employs the three analysis for the strategic design of a modular, customizable smartphone. Both applications illustrate the usefulness of the proposed analyses and provide suggestions about cyber-physical systems design.

The change propagation sensitivity analysis demonstrates that system architecture does influence the change propagation behaviour. The subsystems' degree, the system diameter, the number of component loops and the structural complexity are the four most correlated features with the change propagation indices evaluated.

As far as the customizable smartphone case study is

concerned, the distributions of change indices indicate that the evaluation of changeability depends on factors like the agent performing the change and the lifecycle phase during which the change is made; furthermore, a change in the platform core or the CPU module is likely to generate many propagated changes. The Logit value analysis forecasts that basic screen modules, mono loudspeakers, fingerprint readers, high-speed interfaces and 750 mAh batteries will be the most appreciated modules in a customizable smartphone. Finally, the sociotechnical simulations highlight how sustaining the platform ecosystem can be as important as initiating it correctly. The sensitivity analysis indicates that the initial number of modules is fundamental for the entire growth of the communities and that each month of product development saved can increase the developers' community size by five participants. From the same analysis, it appears that

a 12.5% rate of malfunctioning platform architectures is sufficient to make the entire market collapse.

A long-term scenario for the development of the research field about cyber-physical systems and ecosystem innovation concludes the work. Three interrelated research directions are envisioned: cyber-physical social systems, massive customization and fluent engineering design. The first one focuses on the interactions between human behaviour and cyber-physical systems, the second one explores the freedom of choice offered by customization-intense products and its implications on both the customers' attitudes and the logistics chain management. The last one studies how agile product development methods and lean manufacturing can benefit from a constant feedback of data from the actual system operation.

PROBABILISTIC MODELING OF AIRFRAME DAMAGE PROPAGATION FOR REAL-TIME PROGNOSIS

Matteo Corbetta - Supervisor: Prof. Marco Giglio

Tutor: Prof. Alfredo Cigada

Fatigue damage progression is a major concern in the aeronautical domain, affecting structure's durability, reliability, availability and safety as well. It can be considered one of the main obstacles to the application of condition-based maintenance or predictive maintenance approaches. For this reason, the scientific community is performing extensive research on structural health monitoring (SHM) systems for real-time diagnosis of aerospace structures. The diagnostic process aims to identify and localize structural damages, distinguish among several damage types and assess their dangerousness. A SHM system capable of characterizing the state of the structure in real-time is highly desirable so. Despite research on SHM requires a considerable amount of further work, another opportunity arises from the availability of real-time SHM data: the real-time prediction of the structure's remaining useful life (RUL) thus carrying out the prognosis of the system. Research on real-time damage prognosis of aerospace structures has been limited so far, given the complexity of the problem involving (i) an effective diagnostic system, and (ii) interdisciplinary knowledge about structural and damage mechanics,

uncertainty representation, uncertainty quantification and theory of stochastic processes. They are the basic tools for a real-time probabilistic framework able to propagate the uncertainty in the future and to evaluate the time-to-failure of the system using effective, quantitative representations like probability density functions (PDFs). To that end, the thesis investigates the real-time stochastic modeling of fatigue damage progression using a promising sequential Monte Carlo method commonly referred to as particle filtering (PF) algorithm, suitable for real-time applications. It is a model-based numerical approach to solve the Bayesian prediction-updating problem when other filtering methods (i.e., Kalman filters) fail because of high-nonlinearity and non-Gaussian PDFs [1]. First, the algorithm requires a damage propagation model to predict the future damage extent caused by fatigue loads. The next step is the embedding of the model into a stochastic framework able to account for the uncertainty of both the measurement system and the propagation phenomenon. Such a stochastic framework grounds on the dynamic state-space model in discrete time domain (1).

$$\begin{cases} \mathbf{x}_k = f(\mathbf{x}_{k-1}, \boldsymbol{\theta}, \boldsymbol{\omega}_{k-1}) \\ \mathbf{z}_k = g(\mathbf{x}_k, \boldsymbol{\eta}_k) \end{cases}$$

Where \mathbf{x} is the system's state, $\boldsymbol{\theta}$ is the model parameter vector and \mathbf{z} is the observation of the (hidden) system's state. The two random processes $\boldsymbol{\omega}$ and $\boldsymbol{\eta}$ represent the model uncertainty and the observation uncertainty, respectively. The filtering problem consists in recursively estimating the conditional PDF of the system's state given a series of observations. It can be efficiently performed using PF, i.e., generating Monte Carlo samples $\mathbf{x}_k^{(i)}$; $i = 1:N_S$, which represent the system's dynamic, weighted by the likelihood of the observations (2).

$$p(\mathbf{x}_k | \mathbf{z}_{0:k}) \approx \sum_{i=1}^{N_S} w_k^{(i)} \delta_{\mathbf{x}_k^{(i)}, \mathbf{x}_k}$$

$$\tilde{w}_k^{(i)} = w_{k-1}^{(i)} p(\mathbf{z}_k | \mathbf{x}_k^{(i)})$$

$$w_k^{(i)} = \frac{\tilde{w}_k^{(i)}}{\sum_{j=1}^{N_S} \tilde{w}_k^{(j)}}$$

Where $w_k^{(i)}$ is the weight of the i -th sample, and $p(\mathbf{z}_k | \mathbf{x}_k^{(i)})$ is the likelihood of the observation [1]. The filtered estimation is projected in the future using the damage progression model to estimate the RUL of the damaged structure. First, the thesis examines the stochastic equation f and provides

an optimal, unbiased formulation for nonlinear monotonic fatigue damage processes, pointing out the strengths of the proposed solution against the existing literature (3).

$$\mathbf{x}_k = \mathbf{x}_{k-1} + f'(\mathbf{x}_{k-1}, \boldsymbol{\theta}) e^{\boldsymbol{\omega}}$$

$$\boldsymbol{\omega} \sim \mathcal{N}\left(-\frac{\sigma^2}{2}, \sigma^2\right)$$

Where f is the fatigue damage growth rate. The methodology is capable of predicting the RUL of damaged structures subject to fatigue, and has been applied to many scenarios. First, the algorithm has been applied to relevant fatigue crack growth (FCG) data from Aluminum aeronautical stiffened structures and the prognostic performance is

validated using dedicated metrics (figure 1).

The thesis develops also a multi-dimensional prognostic framework for fiber-reinforced polymers (FRP). A detailed review of existing damage models for laminates has been provided, and a multiple damage-mode model to estimate the strain energy release rate G of FRP exhibiting matrix cracks and delamination has been selected for the framework (3), [2].

$$G \propto \frac{\sigma_0^2}{E_x(\rho, D_y)} (E_{x,lam} - E_{x,detam})$$

$$\rho_k = f_\rho(\rho_{k-1}, G, \boldsymbol{\theta}, \omega_\rho)$$

$$D_{y,k} = f_{D_y}(D_{y,k-1}, G, \boldsymbol{\theta}, \omega_{D_y})$$

$$S_k = f_S(\rho_k, D_{y,k}, \omega_S)$$

Where ρ is the matrix crack density, D_y is the transverse delamination and S is the remaining stiffness; all are described by progression models that interact to one another. The multi-dimensional system's state helps in describing the interacting damages and in predicting the RUL (figure 2).

Further, the thesis examines the application of PF for real-time damage prognosis of structures subject to random loading fatigue. The PF-based algorithm allows the prediction of the RUL assuming the hypothesis of stationary random loads, discussing two specific cases. Eventually, PF has been extended to perform both diagnosis and prognosis of the monitored structure in presence

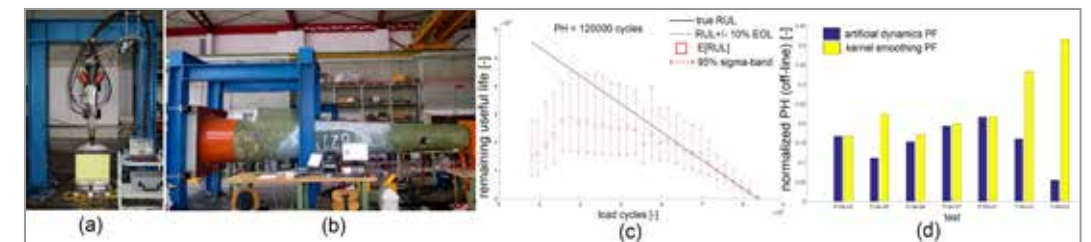

1. Aeronautical panels subject to tension-tension fatigue (a) and a real helicopter tail (b) have been used as case studies. The algorithm is able to predict the RUL of the structure many cycles before the true failure (c), and its performance has been assessed using metrics like the prognostic horizon (d).

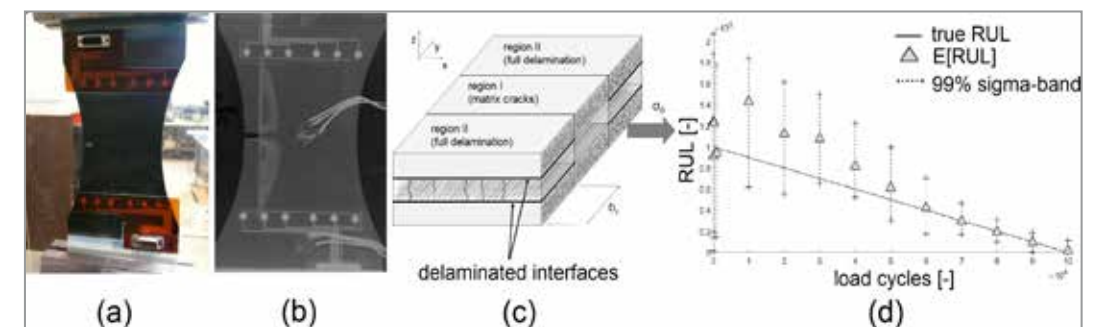

2. Notched cross-ply carbon FRP under tension-tension fatigue (a), X-ray images showing matrix cracks and delamination (b), modeling approach for the estimation of G (c) and RUL prediction using PF (d).

of uncertain diagnostic data using the in [3].

The final part of the thesis emphasizes strengths and limitations of PF for real-time damage prognosis and the considerable amount of work that should be addressed to move towards prognostics in SHM, giving some of the author's thoughts on the future directions.

References

[1]. Doucet, S. Godsill, C. Andrieu. On sequential Monte Carlo sampling methods for Bayesian filtering. *Statistics and computing* 2000;10(3):197-208.

[2]. J. Zhang, C. Soutis, J. Fan. Effect of matrix cracking and hygrothermal stresses on the strain energy release rate for edge delamination in composite laminates. *Composites* 1994;25(1):27-35.

[3]. V. Kadiramanathan, M. H. Jaward, S. G. Fabri, M. Kadiramanathan. Particle filters for recursive model selection in linear and nonlinear system identification. *Proceedings of the 39th IEEE Conference on Decision and Control* 2000;3:2391-2396.

3D FINITE ELEMENT MODELING OF MICRO END-MILLING BY CONSIDERING TOOL RUN-OUT, TEMPERATURE DISTRIBUTION, CHIP AND BURR FORMATION

Ali Davoudinejad - Supervisor: Prof. Massimiliano Annoni

Micro milling requires an accurate management of all the involved resources (machine tool, tool, fixtures, workpiece, etc.). Specific attention has to be paid compared to macro operations, due to the small scale and several difficulties can be faced both with physical experiments and simulations. Micro milling is a rather complicated process to simulate due to the involved complexities, such as geometrical, mechanical, tribological, thermal and chemical. There are many differences between manufacturing in macro and micro scale, which cannot be simply considered with downscaling approaches, due to the difficulties and challenges that need to be considered in micro machining. Predictive models for machining operations have been significantly improved with numerous methods in the last few decades. Without successful models, expensive experimental testing will continue to dominate the practical process development. So far, not many 3D finite element models (3D FEM) have been presented by taking into account the exact geometry of a micro tool along with their experimental validation in micro milling. This study discusses the performance of a

3D FEM approach for the micro end-milling process on Al6082-T6 with TiAlN-X coated carbide micro end-mills. FE models shows some important advantages, i.e. they can easily deal with any kind of tool geometry and any side effects affecting chip formation such as thermal aspects and material properties changes. A number of FE simulations were performed at different cutting conditions (full slot and up-milling contouring micro end-milling operations) to obtain realistic numerical predictions of chip flow, temperature distribution, cutting forces and burr formation. Two different approaches for modeling the cutting tool were applied in order to correctly model the exact geometry of the micro end-mill. According to the first modeling approach, the cutting tool was modeled in the FE software based on the measurements carried out on the tool geometrical features by an optical microscope (Alicona Infinite Focus ®), however, this method could not follow the exact geometry of the tool. Then another approach was applied based on the 3D cloud of points acquired by the same microscope, which has been used to build a more realistic tool model for the simulation. A 3D FE model, as the one used

in this study, is able to consider the effects of the mill helix angle and cutting edge radius on the chip. Due to the small chip size in micro milling, extremely fine meshes and related remeshing techniques were used and consequently the computation time was increased. The Johnson-Cook material model was used as constitutive material model and the constants of the model were determined by an inverse method based on the experimental cutting forces acquired during the micro end-milling tests. The correct selection of these constants is a very important step to predict with a reasonable accuracy forces, temperature, chip morphology, etc. The FE model prediction capability was validated by comparing the numerical model results with experimental tests. In each part of the model such as, inverse method for material modeling and tool geometry modeling approaches, different set of experiments were carried out to investigate the capability of the model in different cutting conditions. Chip formation and temperature distribution in the cutting area were in good agreement with the experimental results and correlations were observed in terms of burr dimension trends and force

profile shapes and magnitude with the 3D tool geometry modeling approach. Furthermore, the tooling geometrical effects on the micro end-milling performance were investigated and compared against physical experiments and another modeling technique. The performance of the FEM prediction were compared with the performance of a state-of-art mechanistic model, capable of including minimum chip thickness aspects as well as effective rake angle effects.

ADVANCED RELIABILITY ASPECTS OF ULTRASONIC NON DESTRUCTIVE TESTING AND STRUCTURAL HEALTH MONITORING APPLIED ON METALLIC COMPONENTS

Andrea Gianneo - Supervisor: Prof. Michele Carboni

This Ph. D. thesis focuses on advanced reliability aspects of ultrasonic Non Destructive Testing and Structural Health Monitoring applied on metallic components. Particularly, capability evaluations are investigated by means of a recently developed, within the NDT field, Multi-Parameter POD approach that overcomes the main limitation of the traditionally based Berens' statistical framework that leads to a one-parameter POD curve describing the probability of detection against the flaw size. Different key factors can define the ultrasonic response, like flaw size, orientation, depth, attenuation... and the optimal way of combining all these aspects is a Multi-Parameter POD. Combining experimental and modelled data, a "Master" POD can be established as a function of the modelled data and subsequently it can be split into the single dependencies. In this way the number of flaw samples is drastically reduced to completely describe all influencing factors as well as the dispersion of results since the main key factors are now taken into account in the POD formulation by means of numerical simulations. Otherwise, the confidence bounds will be larger because of

the inflated level of scattering. Firstly, capability formulation in a multi parameter perspective is investigated regarding the inspection of thick-walled (54mm) copper canisters for final disposal of spent nuclear fuel, where ultrasonic inspection using phased array technique (PAUT) is applied. Because thick-walled copper is not commonly used as a structural material, previous experience on Phased Array Ultrasonic Testing for this type of application is limited in the literature. Consequently the coarser grain size and grain size distribution, high level of attenuation are involved, leading to a low pass filtering effect of the ultrasonic signal and a shift of the sound beam focal point; moreover canisters can exhibit different and heterogeneous GSD along the depth. Therefore, ultrasonic attenuation behavior differs both between different canisters from different manufacturing processes and within the same canister, leading to a troublesome task in defining POD. As well as within NDT field, also in SHM approaches, several deterministic factors, like flaw morphology, size, orientation respect to SHM network, concur in defining the response. Variability is introduced by the surface mounting process (not

reproducible), piezo-electric constants... Thus, a preliminary Multi-Parameter POD approach is investigated for an ultrasonic Guided Waves Based SHM method regarding plate like structures made of aluminum alloy.

The work here summarized was performed at Politecnico di Milano, Department of Mechanical Engineering, and at the Bundesanstalt für Materialforschung und -prüfung (BAM) in the research group "Reliability of Non-Destructive Testing" belonging to the department of Non-Destructive Testing, in cooperation with the Swedish Nuclear Fuel and Waste Management Company (SKB).

The Ph. D. thesis is structured in three main chapters:

Chapter 1: State of the Art.

An overview of the current state of art is given, particularly focusing on the topics involved in ultrasonic Non Destructive Testing (NDT), Structural Health Monitoring (SHM), and Reliability concepts. Firstly, the main notions of ultrasonic NDT are introduced, regarding both conventional techniques, based on monolithic probes, and advanced ones, i.e. Phased Array techniques as

here investigated. The effects of ultrasonic attenuation are discussed in terms of different sources of attenuation, grain size and grain size distribution. Then, the concepts of SHM technique Guided Wave based are described regarding the propagation and interaction in plate-like structures made of isotropic materials. Lastly, NDT reliability, capability evaluation and developments in Probability of Detection (POD) modeling are presented; a lack of information is pointed out regarding the reliability in SHM approaches.

Chapter 2: Reliability Assessment of Phased Array Ultrasonic Inspection in High Attenuating Copper Canisters.

The chapter describes the progress in understanding the amplitudes and attenuation changes acting on the ultrasonic inspection of copper canisters, particularly focusing onto the reliability of Phased Array UT inspection for risk assessment of nuclear waste encapsulation by means of POD curves. The existence of a low pass filtering effect of the ultrasonic signal and a heterogeneous grain size distribution along the depth are considered as affecting both the detectability of defects and

their "Probability of Detection" determination. The difference between the first and second back wall echoes are not sufficient to determine the local attenuation (within the inspection range), which affects the signal response for each individual defect. Experimental evaluations of structural attenuation are carried out onto step-wedge samples cut from full-size, extruded and pierced & drawn, copper canisters; data, from A-scans, are analyzed in a Joint Time Frequency perspective. Effective attenuation values has been implemented in numerical simulations to achieve a Multi Parameter Probability of Detection. A Model-Assisted Probability of Detection, through a Monte-Carlo extraction, is formulated to reduce the experimental efforts in obtaining empirical POD. Limits and advantages of the different developed techniques of stating and deriving POD curves are shown.

Chapter 3: Reliability Assessment of Guided Waves Based SHM Approach by means of Multi-Parameter POD Curves.

The application of a Multi-Parameter POD approach is proposed with the aim of

analyzing the sensitivity of a SHM system based onto a PZT sensors network. Different uncertainty factors, like the surface mounting process (not well reproducible), piezo-electric constants, and deterministic ones like flaw size and orientation with respect to PZT network, contribute to define the variability of the process. The capability of such a system is described in a Multi-Parameter perspective. As well as developed within the NDT field, numerical and experimental data from artificially flawed aluminum plates are combined to establish a "Master" POD curve by means of which the dependence on any single factor, i.e. flaw size and orientation, are established.

MODELLING OF HYDROGEN EMBRITTLEMENT PHENOMENON: DIFFERENT PERSPECTIVES AND DIMENSIONAL SCALES

Giorgia Gobbi - Supervisor: Prof. Laura Vergani

Tutor: Prof. Barbara Previtali

Hydrogen embrittlement (HE) phenomenon is a scientific issue known since several years in engineering field. It consists in the degradation of the mechanical properties of several structural steels and alloys exposed to atomic hydrogen. Nowadays, the ever-increasing need for energy requires the development of new oil and gas fields around the world, which are becoming more and more demanding in terms of service environment and operating conditions. On the other hand, the application of renewable energy sources, among which hydrogen is a promising choice, is a popular alternative trend. In both situations, metal pipelines and infrastructures operate in presence of hydrogen, with high risk of hydrogen embrittlement. Typically, effects of hydrogen cause failure of components or structures with catastrophic consequences for environment, industrial economy and personnel health. Therefore, this makes hydrogen embrittlement phenomenon a common challenge that needs to be addressed in energy fields. In order to design efficient components, ensuring environmental and human safety during their service life,

it is essential to have a reliable database of experimental tests as well as numerical tools able to predict the mechanical response of the material to extreme environmental conditions. Further, understanding the mechanisms of hydrogen embrittlement is an essential prerequisite of an accurate design. To this end, the present thesis deals with both experimental tests and numerical modelling of hydrogen embrittlement phenomenon on a low alloy high strength steel, AISI 4130, commonly used for hydrogen storage vessels. The thesis consists of three main parts: one experimental and two numerical at different dimensional scales, macroscale and atomistic-mesoscale. As regards the experimental

part, fatigue crack growth and fracture toughness tests were carried out on as-received and electrochemically hydrogen precharged specimens. The investigated steel showed a high sensitivity to hydrogen effect, with an increased crack growth rate of two-three orders of magnitude with respect to the as-received material (Fig. 1). Similarly, the results indicated that the fracture toughness was reduced to 70% due to the presence of hydrogen (Fig. 2 left).

The fracture toughness data, CTOD- Δa (crack tip opening displacement-crack extension), was used for the calibration and validation of two macroscale cohesive finite element models aimed at reproducing the effect of hydrogen on the mechanical behaviour of the current steel

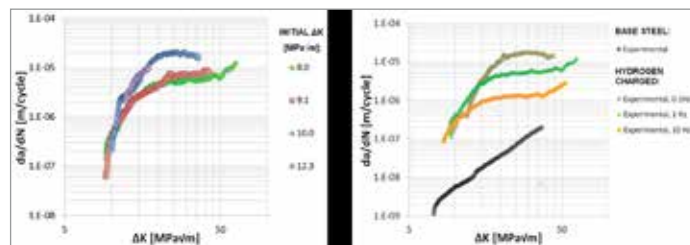

1. Effect of different initial ΔK on fatigue crack growth tests for hydrogen-charged specimens tested at frequency 1 Hz (right). Effect of different testing frequencies (left) on fatigue crack growth rate for hydrogen-charged specimens.

(Fig. 2). The common feature between the two models is that the material response to crack propagation is simulated by means of a cohesive law, i.e. stress-displacement curve. It represents phenomenologically the behaviour of the material during crack growth. Thus, the embrittlement effect of hydrogen was simulated by reducing the cohesive strength proportionally to the total hydrogen concentration. This technique allows to reproduce the Hydrogen Enhanced DE-cohesion (HEDE) micro-mechanism at macroscale. The first model was developed in three subsequent steps of simulation not fully coupling hydrogen diffusion and stress analyses during crack propagation. On the other hand, the second model was developed in a unique step of simulation fully coupling the analyses by means of the implementation of supplemental codes.

Both models agreed in the estimation of the mechanical behaviour in presence of hydrogen. The slight difference between the experimental data and the numerical prediction is attributable to the fact that probably the HEDE mechanism is not the only active mechanism into the steel. Moreover, the literature microstructural relationships employed to calculate the trapping hydrogen content are general and perhaps not accurate enough for all materials. However, the sensitivity analysis proposed on the three-step model, which was developed varying both material

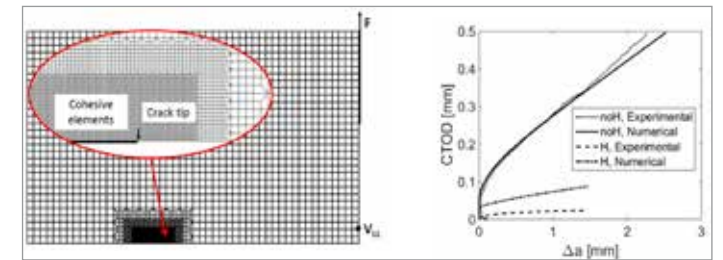

2. Representation of the simulated specimen with the refined mesh around the crack tip. The force F is calculated as reaction force of the applied displacement and the VLL is the load line displacement (right). Numerical and experimental results: solid line outcome of the calibration process and dash-dot line results of the models (left).

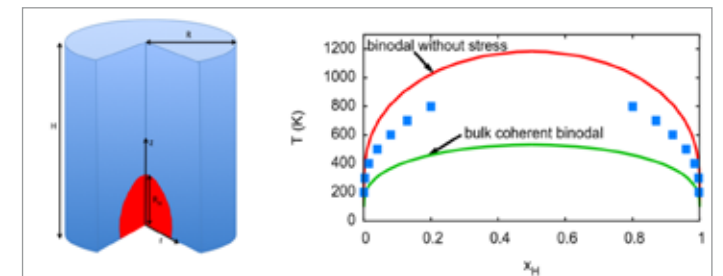

3. Sketch of the geometry for the finite element simulations of the continuum field model. The entire sample has a cylindrical shape; all surfaces, top, bottom and mantle are stress free. A hydride is nucleated near the lower surface, shown here in red. The system has a cylindrical symmetry, which allows to reduce the problem to a two-dimensional description (right). The phase diagram with the coherent surface binodal, obtained from the continuum field model (blue data points). The focus is here on the low temperature data (left).

dependent parameters and hydrogen concentration, proved its efficiency as a predictive tool in simulating hydrogen effects under different conditions. Finally, the last part provided a fundamental physical perspective in the investigation of hydride formation as possible mechanism to explain hydrogen embrittlement. In particular, we investigated phase separation for different metal-hydrogen systems in bulk and at surfaces with a multi-scale approach that links ab initio and continuum

description at mesoscale. We found a reduction of the solubility limit near free surfaces due to the release of elastic coherency stresses (Fig 3). This mechanism favours hydride nucleation from free surfaces even in absence of external stresses. Thus, the presence of hydride brittle phases can trigger a crack into the material even without an applied load.

STUDY OF RAIL VEHICLE DYNAMICS AND WHEEL-RAIL CONTACT USING FULL-SCALE ROLLER RIGS

Binbin Liu - Supervisor: Prof. Stefano Bruni

Rail vehicle dynamics and wheel-rail contact mechanics are two relevant issues in railway engineering and have been subjected to extensive research since the advent of railways. The powerful computing technique facilitates the problem solving process. However, the conclusions coming from numerical simulations cannot be applied into practice before validation normally by experiments in laboratory or field. The field experiments for these purposes are often challenging due to the difficulties in adequately controlling the test conditions. Roller rigs are a good alternative in this case because they can offer a repeatable environment for a specific test and allow for the use of multiple sensors and data acquisition equipment either difficult or impossible to use in the field. Full-scale roller rigs for tests on a single wheelset are recognized as useful test stands to investigate wheel-rail contact/damage issues and to develop new solutions to extend the life and improve the dynamic behaviour of railway systems. The replacement of the real track by a pair of rollers on the roller rig causes, however, inherent differences between wheel-rail and wheel-roller contact. In order to ensure efficient utilization of the roller rigs and correct

interpretation of the test results with respect to the field wheel-rail scenarios, the differences and the corresponding causes must be understood a priori.

The aim of this thesis is to derive the differences between these two systems from both contact mechanics and dynamics points of view based on a full-scale single wheelset roller rig and to find the influence factors of the differences, with the final aim of better translating the results of tests performed on a roller rig to the field case, demonstrating the ability of the experiment and further exploiting the best potential of this test equipment for rail vehicle dynamics and wheel-rail contact study.

In this thesis, an approximate non-Hertzian contact model has been developed for dealing with the wheel-rail and wheel-roller contact problems, which is an extension of the well-known Kik-Piotrowski model with some significant improvements in the accuracy and wider application scope. Furthermore, advanced methods have been proposed to best reproduce the dynamic behaviour of a wheelset in a running condition of interest as obtained either from multibody system simulation or from on-track

measurements based on the existing theories and experimental experiences, which will mark a step forward with respect to presently existing methods and allow for much increased accuracy of the roller rig tests and widening the scope of ability of this kind of facility. Based on the testing methods developed in this thesis, two typical tests namely the curving test and the wheel wear test on a full-scale roller rig are described in detail. The proposed contact model and roller rig testing methods are expected to be of benefit to a number of institutions which operate roller rigs.

AN EFFICIENT CONDITION MONITORING APPROACH FOR RAIL VEHICLE SUSPENSION SYSTEM BY USING MODEL-BASED ASSESSMENT

Xiaoyuan Liu - Supervisor: Prof. Stefano Bruni

Modern railway transportation is emphasizing on the optimization of the rolling stock maintenance to enhance safety, reliability and comfort, meanwhile reducing life-cycle costs. Under this framework, the condition based monitoring (CBM), as a technique to provide prognosis and diagnosis of component degradation, allows to detect the in-service failures and contributes to the decision-making for improving the system performance. Distinguished from the conventional fault detection carried out in the depot, this technique is aiming at the online identification of the component performance on the operational conditions. This thesis is concerned with the condition monitoring of the vehicle suspension based on the measurements by vibration sensors mounted on the vehicle. The fact that the vehicle motion caused by the irregularity of wheel/rail interface serves as a 'natural exciter' for the vehicle suspension component is evidently contributing to the feasibility of this vehicle-based condition monitoring system. Concerning the condition monitoring of the vehicle suspension system, it is very necessary to point out that the condition monitoring approach needed should be adaptive to the realistic occasion of the suspension system. In reality,

the signals related to the vehicle suspension system has many unique characteristics compared with other dynamic system. For instance, these vibration signals exhibit the noisy, transient and wide-band features. This could constitute an obstacle to realize the fault detection for the springs or dampers of the vehicle due to the lack of the explicit sign revealing the performance of the suspension system. On the contrary, the vibration signals in a suspension system also present the zero-mean, deterministic and correlated characteristics. However, these characteristics can be very valuable in the parameter identification of suspension component and could contribute to the fault diagnosis of the suspension system. The diagnosis techniques for the vehicle suspension system can be divided into data-driven and model-based methods. Considering the issue in this thesis, the fault diagnosis of the primary vertical suspension system, the limitation of the data-driven method is more likely to hinder its application to this task. In this thesis, the Random Decrement Technique and Prony method are used to illustrate the difficulties of the data-driven method in solving the problem regarding a coupled dynamics system. In contrast, the model-based

method is more preferable in the condition monitoring of the vehicle suspension system because of its capability in the parameter estimation. It is evident that the fault of the suspension component normally results in a certain deviation from its nominal parameter value. However, the parameter deviation may not result in a noticeable change in the state of the vehicle system, especially considering a coupled dynamics system. In this sense, the parameter identification should be the essence of the model-based condition monitoring algorithm rather than the state estimation, because the most state variables are not unobservable but can be measured in a direct or indirect way. Oriented to the fault diagnosis of the suspension system with a parameter estimation approach, an efficient model-based condition monitoring solution for the rail vehicle suspension is proposed under the framework of recursive least-square algorithm. RLS algorithm is equipped with the memory and machine learning features and has the capacity to identify multiple-parameters simultaneously from an input-output model. As a special case of the Kalman filter, RLS also allows for the parameter identification in a noisy system. Because the suspension component functions in

accordance with the relative motion by its connected bodies within a specific frequency range, the relationship between the relative motion for the suspension and the absolute acceleration of the sprung mass is deterministic and can be utilized to estimate the suspension parameter.

The estimation of suspension component can be achieved by utilizing the relationship between the excitation and response of a vehicle system. The excitation is the relative motion for the suspension component, while the response is the acceleration signal of the sprung mass concerned at the same time. In this way, the acceleration of the sprung mass at the certain time only depends on the corresponding suspension loads. The significance of this perspective is that the suspension parameters can be regarded as 'state' variables and the measured vibration signals can be reckoned as 'parameters' of the dynamic observation models, as a viewpoint of system identification is adopted. Focusing on the correlation property of the system, this RLS-based approach is especially useful for the fault detection of the suspension components in a coupled system with parameter uncertainties.

Correspondingly, in this thesis a condition monitoring strategy for the vertical suspensions in one railway bogie was introduced and validated via numerical simulations and field test results. The simulation results from the rail vehicle dynamics software 'ADTreS' are employed as 'virtual measurements' concerning a trailer car configuration of an ETR500

high-speed train. In the numerical simulations, several faults are considered simultaneously in the primary vertical suspension, including the damper failures and spring degradation. Based on this validation, the suspension parameter estimates are in good agreement with the values used in the numerical simulations, which provides the straightforward results for the fault detection and isolation. Due to the optimal solution provided by RLS, the identification process also exhibits a stable and fast convergence for the parameter estimation. It can be noticed that the derivative form is more precise in the parameter estimation with a higher convergent speed and more robust with the measurement noise than the original form. This phenomenon reveals that RLS filtering is further suited with the variables of high correlation properties. Theoretically the degradation process of the suspension component can be identified by introducing the forgetting factor or process noise. Definitely the value for the forgetting factor or the covariance matrix of process noise needs to be chosen for the balance of the estimation performance and response speed.

To verify the feasibility of this strategy in a real application, the measurements from a prototype condition monitoring system implemented on an E464 passenger locomotive are utilized. In reality, the vibration signals related to the observation model are hidden in the noises. In this sense, a band pass filtering is needed to alleviate the effect of the noise to the

identification model. Associated with the acceleration signals measured from the bogie, the RLS-based algorithm with uncertainties provides convergent estimates for all suspension parameters due to the optimal Gauss gain. Owing to the Kalman filtering features of RLS, the parameter estimates are approximate to the reference values, even though the observation model is contaminated by noises. It can be seen that this RLS-based approach is able to extract the valuable parameter information and eliminate the redundant information in the perspective of the observed dynamics model. Therefore, these identification results based on the real measurements provide the supporting evidence of this condition monitoring strategy for its further application in engineering. This work is aiming at providing a more universal platform for the development of the condition monitoring system for the vehicle suspension. With the concept mentioned here, more relevant CBM solutions dedicated to their purposes could be foreseen in the future. The main advantages of RLS-based condition monitoring methods are summarized as follows:

- Allowing for multiple-fault detection in a coupled dynamics system;
- Possibility to adopt a simple vehicle dynamics model with more uncertainties;
- Robust convergence property to ensure the identification stability;
- Very low computation cost, well suited for the on-line diagnosis system.

STUDY AND METROLOGICAL CHARACTERIZATION OF STEREOSCOPIC SYSTEMS

Giacomo Mainetti - Supervisor: Prof. Remo Sala

In many application field, especially in the industrial one, 3D non-contact sensors are always more diffused, thanks to technology development. One of these techniques is the object of this work, which aim is the study and metrological characterization of multi-cameras stereoscopic systems. The need of a measuring system usable in a wide variety of application fields, with different environment conditions and working volumes and able to perform dynamic measurements, has led to the choice of stereoscopy.

In order to perform a metrological characterization of a stereoscopic system, it is very important to analyze the calibration process and to investigate how this affects the final 3D measures. The first part of the work is therefore dedicated to the study and comparison of the main camera calibration algorithms existing in literature. In particular the Zhang method, optimized with a Levenberg-Marquardt (LM) minimization algorithm has been compared to the Heikkilä technique. From these analyses, it has been demonstrated that the accuracy of the two techniques is compatible.

A three-camera system has been developed and a series of test have been performed

on it, in order to metrologically characterize the stereoscopic technique. First of all the calibration process of the stereoscopic system has been deeply analyzed, based on Heikkilä method. This algorithm optimizes the 2D back-projection error, that is the distance in pixel between the calibrator points in the images and its back-projected points, calculated with the calibration parameters. The 2D error is commonly used to define the calibration goodness and the dependence of it on the 3D measurement accuracy has been investigated in this work. In particular the 3D accuracy has been studied calculating two different 3D errors: the "distance 3D error" and the "translation 3D error". The first one is defined as the deviation of the measured calibrator points distances from the real values. The second one is the deviation of the measured distances of calibration points in different poses from the real value. It has been possible to calculate the real distances between different poses because the calibration pattern has been moved with an anthropomorphic robot; so it has been returned by the robot with negligible uncertainty. From the results of these analyses, it has been shown that the 2d back-projection error

is generally a good indicator of 3D measurement accuracy. When 2D error value increases, also 3d errors values increases. Only for very low 2D error values, when the calibration process has bring to good results, the 3D errors remain constant.

In order to perform a good calibration, it has been demonstrated with a series of tests that it is advisable to acquire at least 15 different poses of the calibration pattern. All the calibrator poses must cover the entire workspace and have different orientation and positions. The calibration plate must be entirely visible in all images, well on focus and homogenously illuminated.

The uncertainty introduced by the data acquisition process from calibrator images has been estimated with some experiment and its propagation in the calibration process has been studied using Monte Carlo method. With a series of simulations, the probability distribution of calibration parameters has been estimated. In order to understand the effects of these uncertainties on the 3D measurement accuracy, a sensitivity analysis has been performed on the 3D reconstruction process. From the results of the metrological

qualification of the three-camera system, the uncertainty value has been estimated of few tenths of millimeter. The maximum uncertainty value has been found in the coordinate perpendicular to the sensor plane.

The results of the metrological qualification of a three-camera system has been used to implement solutions optimized for three different application fields: wind tunnel measurements, automatic robot programming and robot vision for bin-picking of randomly disposed mechanical parts. For each of these applications, a dedicated stereoscopic system has been



1. Wind tunnel sail shape measures with the stereoscopic system.

implemented and it has been metrologically qualified and validated through a series of experimental analysis. The first application is born from Wind Tunnel of Politecnico di Milano needs of measuring with no-contact sensor the displacement of objects subjected to wind force. A stereoscopic system has been developed for this application. This guarantee flexibility and scalability and it can

be used in different experimental campaigns. It performs dynamic 3D measurements of particular reflecting markers that are placed on the studied object. The system has been validated with different experiments, comparing the 3D measurements to accelerometers measurements. It has been applied to different experimental campaigns, from nautical field to infrastructures. One of the most interesting one is the sail shape reconstruction of a boat model. The possibility of measuring the real sail shape allows sailmaker to compare the acquired data with the theoretical design shape. A series of geometric parameters can be extracted from the 3D



2. Automatic robot programming application

sail shape reconstructions; these parameters give important information about the particular sail shape efficiency. The second application case is born from a collaboration with ABB Robotics Italy. In this case, the possibility of reproducing the trajectory of a hand-moved tracking object with an anthropomorphic robot has been analyzed. In particular a



3. Robot bin-picking application using stereoscopy

robot demo that reproduces the movements of a paintbrush has been developed. The brush trajectory is reconstructed with a stereoscopic system. Finally, in the third application case, the bin-picking problem has been faced. A vision system that guides an anthropomorphic robot to pick some randomly disposed mechanical parts in a bin has been developed. This is based on mono-camera stereoscopy, where the camera is moved by the robot hand to take pictures from different viewpoints.

A NEW APPROACH FOR MECHANICAL DESIGN AND QUADRATURE COMPENSATION OF MEMS GYROSCOPES

Damiano Milani - Supervisor: Prof. Ferruccio Resta

Micro Electro-Mechanical Systems are interesting devices that nowadays are becoming of great importance, both for the new frontiers that they open in scientific field and the possible application in industrial products. MEMS are high-tech chips that combine both electronic and mechanical parts on a silicon wafer at very low scale. Subject of the present research are MEMS gyroscopes, that are sensors used in several applications, like Inertial Measurement Unit (IMU) systems, from military-class devices to mobile phones. They measure angular velocity with high accuracy, making them suitable for inertial characterization of moving bodies. Some particular devices called Coriolis Vibratory Gyroscopes are active sensors in which the angular velocity is measured indirectly considering the Coriolis effect. The working principle is based on the fact that two masses are forced to vibrate in anti-phase with a harmonic motion; due to a rotation imposed to the whole system, Coriolis acceleration appears. Considering the mass of the system, the Coriolis force is very weak, and it causes a displacement of the microstructure barely sensed by some capacitors placed strategically. One of the most common processes used in MEMS fabrication is the dry etching

technology, in particular the Deep Reactive Ion Etching (DRIE). This allows to obtain shapes in the silicon layer characterized by high aspect ratios; in particular, it is possible to create slender folded beams, used as elastic suspensions for these micro-mechanical systems. The whole process is based on the projection of an ion beam on a silicon wafer, which etches the material transferring the designed layout. Unfortunately, depending on the location on the wafer surface, the ion beam does not etch the silicon in the same way. Therefore, the MEMS structures do not have the side surfaces perfectly orthogonal to the layer plane. This defect, known as wall angle, is the cause of the so-called mechanical quadrature error. This error causes a Zero Rate Output (ZRO) signal, meaning that a capacitance variation is measured by the device when no angular velocity is applied to the structure. The consequent noise and bias in the measurements are responsible for limited sensitivity and low performance in the device. The present study aims at modeling the dynamics of MEMS gyroscope sensors, analyzing the effect of quadrature error and trying to minimize it by means of mechanical solutions. The optimization of the sensor layout can lead to more reliable devices

and to increased performance. The key points of this new approach are the adaptability to any kind of MEMS gyroscope layout and the possibility to truly prevent the quadrature and not only compensate it through active control a posteriori. To reach the stated target, the first step consists in understanding the working principle of a vibrational gyroscope and the effects induced by quadrature error on the output signal. Since the dynamical phenomena under consideration are in three dimensional space and involve complex geometries, it is convenient to use a FEM software to model the sensors. This is useful to understand the working principle of the structure and to locate the critical points responsible of the quadrature

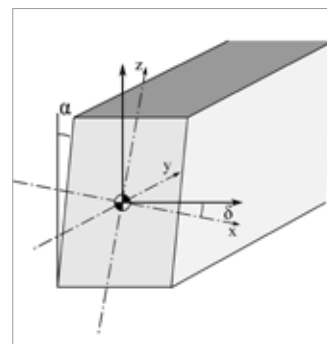

1. A microfabricated elastic element in which the wall angle defect causes a rotation of the principal axes of inertia in the beam section.

error. General purpose finite elements approach presents several disadvantages for this kind of dynamic analysis: above all, the computational time is too high to consider the integration of the numerical model into an optimization routine. Therefore, a hybrid numerical code, called feMEMS, has been developed, that combines a custom finite element solver and a lumped parameter model. The quadrature error is described analytically in this code and this innovative modeling approach is validated through a comparison with general purpose FEM codes. Basic analyses can be performed, like eigenfrequencies and mode shapes extraction. Also the dynamic behavior of the system can be analyzed, considering the frequency response function in presence of an externally applied angular velocity. On this basis, feMEMS has proven to be a fundamental tool, not only for the current study, but also for generic dynamical analysis of MEMS inertial sensors. Thanks to this new simulation approach, two commercially available 3-axis gyroscopes have been analyzed checking their operating frequencies and mode shapes, useful parameters in the numerical analysis of these devices. Thanks to their particular design, these Tuning Fork Gyroscopes can measure angular rate for the roll, pitch and yaw. Particular focus has been given to the quadrature effect on the sensor dynamics, having introduced two performance parameters called Quadrature Equivalent Rate and Quadrature

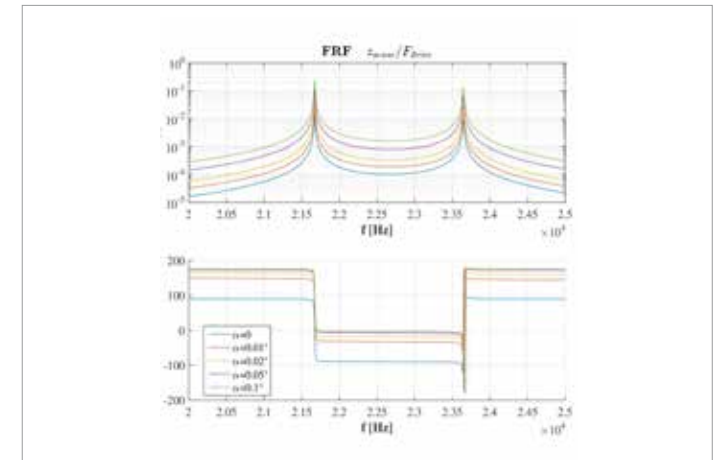

2. Frequency response function of a Coriolis Vibratory Gyroscope along sense direction: quadrature causes an increasing ZRO value at different values of wall angle.

Compensation Factor. The main advantages of feMEMS are that it is very fast, allowing to couple it with optimization codes, and that it easily allows to carry out sensitivity analyses. These features has been used to investigate critical elastic elements from a quadrature point of view. Once the critical elements of typical devices have been identified, new solutions for suspension and transmission structures have been proposed, referred to as counter-bending beams and wheel elements. An optimization routine has been implemented, that exploits the capabilities of the developed hybrid simulation code for identifying layouts that minimize the quadrature effect. The minimization target is the Quadrature Equivalent Rate, i.e. the ratio between the quadrature and the Coriolis effects. Starting from an already implemented configuration, the considered minimization variables are the position of the proof masses of

the sensor, as well as the length, the shape and the stiffness of the folded springs. Therefore, a 3-axis gyroscope which adopt these innovative features has been designed and optimized, ready for being prototyped. This layout presents low quadrature, resulting in an increasing in performance over 20% with respect to the commercially available gyroscopes.

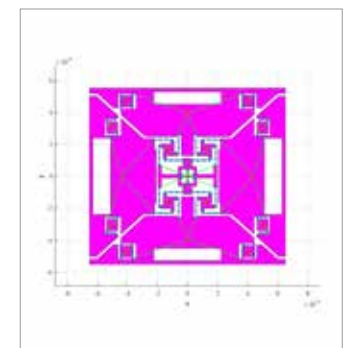

3. Layout of 3-axis gyroscope with low quadrature analyzed with feMEMS approach.

PROPERTIES OF ULTRAFINE GRAINED MATERIALS FOR BIODEGRADABLE APPLICATIONS

Ehsan Mostaed - Supervisor: Prof. Maurizio Vedani

The search for a biodegradable metal simultaneously showing mechanical properties equal or higher to those of currently used permanent biomaterials such as stainless steels, cobalt chromium alloys and nitinol as well as uniform degradation is still an open challenge.

So far, Magnesium (Mg), iron (Fe) and zinc (Zn)-based alloys have been proposed as biodegradable materials for load-bearing applications. Over the last decade extensive research works have been done on Mg and Fe. Fe-based alloys show appropriate mechanical properties, while their very low degradation rate is considered to result in reactions similar to those observed in permanent applications. On the other hand, alongside the insufficient mechanical performance, Mg degradation rate has proved to be too fast and rarely homogenous. In case of Zn, despite an appropriate corrosion rate, which is between Fe and Mg, the mechanical properties are far too low for load-bearing implants. Additionally, processing minitubes for stent application is not trivial; the material must have a good response to laser irradiation during strut cutting, and most importantly, microstructural stability after laser cutting. Despite their

importance, these factors are rarely reported in studies focusing on biodegradable metals development

Accordingly, the objective of the thesis was to adopt strategies aimed at developing materials fulfilling the requirements of biodegradable implants such as proper and homogeneous degradation, high strength, moderate ductility and non-toxicity of the alloy. The thesis is divided in two research works: The first part focused on the improvement of the mechanical and corrosion properties of the commercially available ZK60 Mg alloy through tailoring the microstructure by severe plastic deformation methods. In particular, multi-pass equal-channel angular pressing (ECAP) at different temperatures was carried out aimed at producing ultrafine-grained (UFG) structure and to acquire a better understanding of the effect of UFG structure on mechanical and corrosion properties for potential applications in biodegradable devices.

A comprehensive investigation has been made based on a considerable amount of microstructural characterization techniques to support findings about the mechanical and corrosion behavior of this

material. Instances include electron backscatter diffraction (EBSD) studies of the orientation mapping, grain size distribution, crystallographic texture orientation and slip system activity. Corrosion properties of the investigated samples were characterized in a phosphate buffer solution (PBS) electrolyte. In addition, a thorough mechanical assessment of the material has been carried out and justified in a convincing correlation with the aforementioned microstructural characterizations. Results indicated that after ECAP process a UFG microstructure with average size of 500 nm was successfully achieved. The UFG samples showed a newly stronger texture component featuring basal planes preferentially aligned along ECAP shear plane. A combination of grain refinement and texture modification improved the fracture elongation by about 100% in the UFG sample while keeping a relatively high yield and an ultimate tensile strength of 273 MPa and 298 MPa, respectively. UFG alloys showed better plastic formability than non-ECAP treated samples and therefore, were successfully extruded at 150°C, to produce small-size tubes as stent precursors. The UFG structure

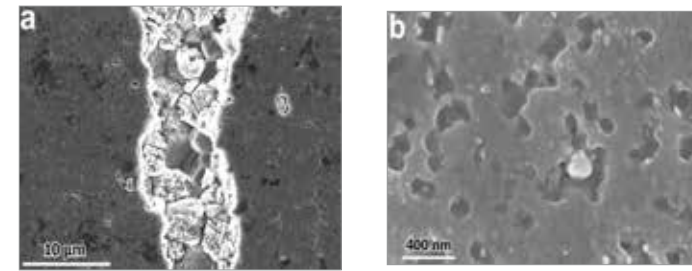

1. SEM micrograph of (a) non-ECAP and (b) UFG ZK60 Mg alloy immersed in PBS solution.

of ZK60 alloy was maintained also after extrusion due to the low processing temperature. Based on the corrosion results, as shown in Figure 1, localized corrosion was observed mainly in the non-ECAP processed sample around the accumulation areas of the relatively large second-phase particles. In UFG alloys in contrast, a shift of corrosion regime from localized pitting to a more uniform corrosion mode was observed mainly due to the second phase refinement and redistribution.

The second dealt with a thorough study on producing novel Zn binary alloy tubes as potential biodegradable materials for stent applications. Pure Zn and several Zn-Mg alloys with Mg contents ranging from 0.15 to 3wt.% are studied in detail.

Furthermore, low Al-content Zn-Al alloys, containing 0.5 and 1wt.% Al are prepared and characterized. The potential for these alloys for stents is assessed by processing minitubes via warm extrusion. Investigation of the prepared alloys relied on a remarkable content of microstructural characterization to support the findings about the mechanical and corrosion behavior of the alloys under study. A comprehensive set of mechanical assessment on the extruded alloys has been carried out in accompany with degradation behavior studies in Hanks' modified solution. Finally, and most importantly, the potential of these alloys for production of stents was evaluated by processing minitubes by a warm extrusion

process followed by laser cutting to investigate the possible microstructural modifications, which would definitely influence the mechanical properties of the final product.

Eventually, as listed in Table 1, improved mechanical properties and corrosion behavior up to the level of currently available materials of this field was established based on the optimized microstructure and concomitant with the correct compositional features. Zn-0.5Mg owing to the combination of improved mechanical properties and uniform degradation, provided the most promising potential for stent application. Further, corrosion-induced mechanical degradation was slowed down far below that of Mg alloys. Ultimately, fixation of microstructure was achieved so that the laser cutting induced grain coarsening and other microstructural instabilities were minimized.

SAMPLE	YIELD STRESS (MPA)	ULTIMATE TENSILE STRENGTH (MPA)	ELONGATION (%)	MICRO-HARDNESS (HV)
Zn	51 ± 3.7	111 ± 4.5	60 ± 5.9	34 ± 1.7
Zn-0.15Mg	114 ± 7.7	250 ± 9.2	22 ± 4.0	52 ± 4.9
Zn-0.5Mg	159 ± 8.5	297 ± 6.5	13 ± 0.9	65 ± 3.9
Zn-1Mg	180 ± 7.3	340 ± 15.6	6 ± 1.1	75 ± 3.9
Zn-3Mg	291 ± 9.3	399 ± 14.4	1 ± 0.1	117 ± 6.1
Zn-0.5Al	119 ± 2.3	203 ± 9.6	33 ± 1.2	59 ± 5.8
Zn-1Al	134 ± 5.8	223 ± 4.3	24 ± 4.2	73 ± 4.6

Table 1. Mechanical properties of Zn and Zn-based extruded alloys.

INNOVATIVE SAMPLING AND DATA PROCESSING TECHNIQUES FOR FOURIER TRANSFORM SPECTROMETERS

Roberto Panzeri - Supervisor: Prof. Saggin Bortolino

The Fourier Transform spectrometers (FTS) are instruments that can be used in space-borne applications to study the chemical composition of the atmosphere or the surface of astronomical objects from the measurement of the emission or reflection spectra. This kind of instruments uses an optical system to divide the radiation in two beams and generates an interference pattern that depends on the optical path difference (OPD) between the two beams once they are recombined. This signal, called interferogram, can be used to compute the spectrum of the input source. FTS are sensitive to mechanical vibrations that can create unwanted OPD. For space-borne it is often unfeasible to develop effective vibration insulation systems due to mass and power constraints. Therefore reducing the error generated by these disturbances in the computed spectra i.e. the instrument vibration sensitivity is a relevant issue.

The spectral ghosts deriving from harmonic mechanical vibrations can be corrected with the implementation of algorithms that recognize the effect of the disturbances and remove their effect on the computed spectra. Procedures proposed in literature

have limits that make them less appealing for space-borne application: as an example a procedure proposed by J.W. Brault requires additional hardware to be implemented. Other procedures, based on the phase demodulation of a reference interferogram are limited in the range of frequencies they can correct.

In this thesis a procedure to compute the spectrum of the input source from the time sampled interferogram, without the shortcomings of the methods proposed in literature, has been developed and implemented. This procedure, called arccosine method, computes the spectrum from the time sampled interferogram and uses the direct

calculation of the phase of a reference monochromatic laser interferogram with the arccosine function to implement the correction of the error generated by mechanical disturbances in the instrument.

The arccosine method has been compared with other procedures based on phase demodulation of the reference laser interferogram in order to evaluate its performances. In the numerical simulation the interferograms of the reference monochromatic laser and a broadband source in presence of a monoharmonic speed disturbance with variable amplitude and frequency have been generated. The performance of three methods have been

compared using a performance index to highlight the deviations between the ideal spectrum with the one computed with each method. To highlight the effect of the correction also the spectrum in case of no correction has been computed. The effect of the level of noise in the signal has been evaluated performing simulations with different signal to noise ratios (SNR).

Other numerical simulations have been performed to evaluate the problem of resampling evenly the computed OPD before the spectra computation. The simulations have been performed using different interpolation procedures with the aim to find a method that allows to perform this operation fast and with low approximation. Experimental tests have been performed using a mock-up of the microMIMA (Mars Infrared Mapper), a double pendulum interferometer, to validate the results of the numerical simulations. The monoharmonic speed disturbances have been introduced using a mini-shaker controlled with a function generator in order test different amplitudes and frequencies of the

disturbance.

All methods have been applied to the measured interferogram of the reference monochromatic laser and of different input source (a HeNe laser and a CalSensor SA727 steady state emitter). Simulations and experimental activity results highlighted the characteristics of the arccosine method:

- 1) It is possible to correct disturbances with frequency higher than the one of the reference laser in the time interferogram f_d . In the method based on phase demodulation this is the carrier frequency, so higher frequency disturbances cannot be detected
- 2) The arccosine correction is more effective when the vibration amplitude exceeds 40% the mean speed of the moving mirror v_0 . The methods based on phase demodulation cannot perform the correction due to the appearance of higher order speed error exceeding f_d .
- 3) The arccosine methods presents numerical problem

if the frequency of the disturbance is a multiple of f_a . In this case problem in the unwrapping of the 2π phase jumps computed with the arccosine may occur.

- 4) The arccosine method presents greater sensitivity to SNR variations and its performances can be worse than the other methods if this parameter is lower than 30 dB.
- 5) Numerical simulations with different resampling procedures applied to the computed OPD showed that third order interpolations, such as pchip and spline allowed to achieve a low approximation in the results and a short computation time.

Experimental tests validated the results obtained with the numerical simulations: when a disturbance with frequency higher than f_a or with high amplitude was introduced, only the arccosine procedure was able to perform the correction, while the spectra computed with the other methods didn't correct the ghost introduced by the speed disturbance.

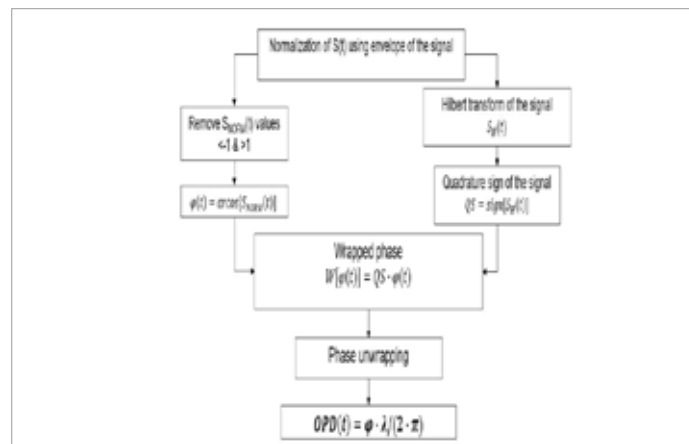

1. Scheme of the arccosine method

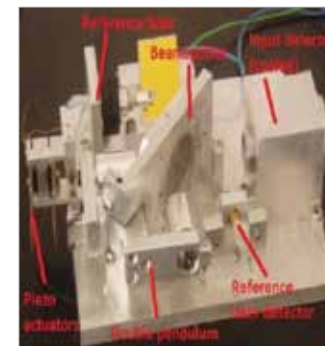

2. The microMIMA interferometer mock-up

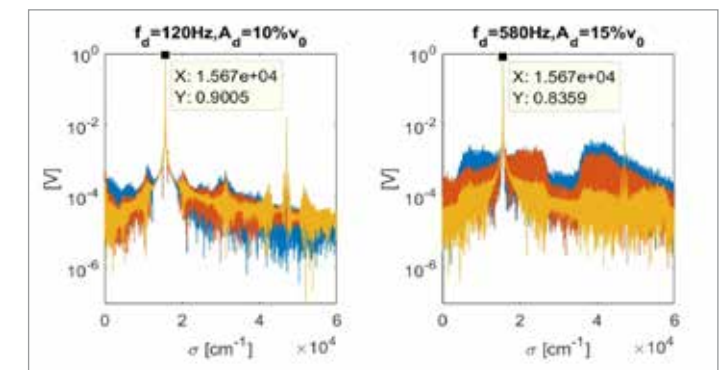

3. Spectrum of the measured reference laser for different disturbance and amplitude frequency computed with Campbell (blue), Hilbert (red) and arccosine (yellow) method

MEASUREMENT AND ANALYSIS OF FREE-FORM OBJECTS. DEVELOPMENT OF A SOLUTION FOR FLYING SAIL SHAPE RECONSTRUCTION.

Ambra Vandone - Supervisor: Prof. Remo Sala

In this research, some novel methods for the acquisition and the analysis of free-form shapes have been proposed. In particular for this study, the flying sail shape has been considered as free-form object to be properly measured and geometrically analyzed. Large differences, in fact, exist between the computer based design shape and the shape assumed by the sail under operational conditions due to different factors such as pressure distribution, sail trimming and



1. TOF acquisition unit: hardware components (left) and software control user interface (right).

fluid structure interaction forces. Nowadays, Computational Fluid Dynamics (CFD) codes assess the yacht performances starting from the design shape; thus, determining the real flying shape can substantially improve the explanatory power of these numerical simulations. A dedicated methodology for both data acquisition and elaboration has been developed.

A custom made Time-Of-Flight (TOF) based device has been realized ensuring non-contact, wide range and robust outdoor measurements. A TOF sensor has been selected to design the core of the acquisition unit (Figure 1-left). The working principle consists in estimating the object-to-sensor distance by evaluating the time a laser pulse takes to reach the target and to come back to the sensor. The laser beam is properly deflected by means of a rotating mirror and a motor

reduction unit, to be able to measure thousands of points in the space. A dedicated software has been implemented to control the acquisition process (Figure 1-right), and a metrological qualification of the device has been performed in order to evaluate the influence onto the measurement of different factors such as target-to-sensor distance, incident angle, target material

and lighting conditions. Then, most efforts have been addressed to the development of a post process algorithm receiving raw data in terms of point clouds and retrieving 3D sail surface reconstructions. Once a scan of the scene at certain time instant is performed, a dedicated software for point cloud elaboration processes the dataset computing the following steps (Figure 2b-d):

- *registration* of the different scans into a common reference system;
- *scene interpretation*: segmentation of the cloud to extract the sail cluster;
- *filtering* of the data to remove outliers and to reduce acquisition noise;
- *modelling*: creation of a surface.

Finally, the reconstructed sail shape is analysed to extract synthetic geometrical parameters such as camber, draft, and twist for a desired number of sections (Figure 2e).

The procedure was validated onto synthetic data sets representing simple scenes and onto design sail shapes provided by sail-makers. The algorithm was used to reconstruct flying sail shapes of scaled model during wind tunnel

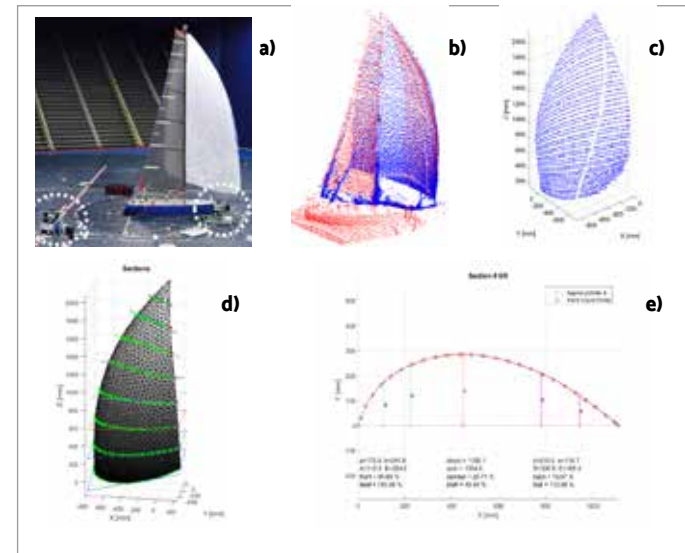

2. Wind tunnel test: experimental setup (a), point cloud registration (b), sail cluster extraction (c), surface reconstruction and sections (d), computed sail geometrical parameters (e).

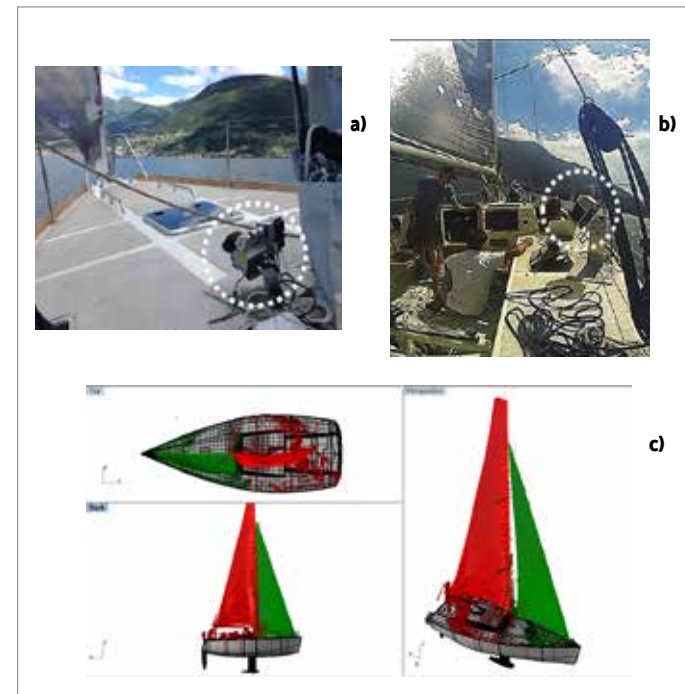

3. Full scale test: experimental setup (a-b), reconstruction of the sail plan for a close-hauled case (c).

campaigns, as shown above, and even for tests on field on the 10 m Sailing Yacht Laboratory boat of the Politecnico di Milano Lecco Innovation Hub project. Figure 3 presents some photos taken during the tests on field and the results obtained.

In conclusion, the aim of this research was to propose some novel methods for the acquisition and the analysis of free-form objects. In this particular study, the shape assumed by the sail during navigation has been considered as free-form shape, thus, acquired in the form of point cloud and reconstructed to provide 3D CAD model in support of a more reliable yacht performance evaluation. A TOF acquisition unit has been designed and patented and a proper post processing algorithm has been implemented leading to promising results and spurring us on to improve measurement accuracy, elaboration automation and computational time.